

(12) INTERNATIONAL APPLICATION PUBLISHED UNDER THE PATENT COOPERATION TREATY (PCT)

(19) World Intellectual Property Organization
International Bureau



(43) International Publication Date
10 May 2001 (10.05.2001)

(10) International Publication Number
WO 01/33464 A1

PCT

(51) International Patent Classification⁷: G06F 17/60

DE, DK, DM, DZ, EE, ES, FI, GB, GD, GE, GH, GM, HR, HU, ID, IL, IN, IS, JP, KE, KG, KP, KR, KZ, LC, LK, LR, LS, LT, LU, LV, MA, MD, MG, MK, MN, MW, MX, MZ, NO, NZ, PL, PT, RO, RU, SD, SE, SG, SI, SK, SL, TJ, TM, TR, TT, TZ, UA, UG, UZ, VN, YU, ZA, ZW.

(21) International Application Number: PCT/US00/30249

(22) International Filing Date:
1 November 2000 (01.11.2000)

(25) Filing Language: English

(26) Publication Language: English

(30) Priority Data:
60/162,932 1 November 1999 (01.11.1999) US

(84) Designated States (*regional*): ARIPO patent (GH, GM, KE, LS, MW, MZ, SD, SL, SZ, TZ, UG, ZW), Eurasian patent (AM, AZ, BY, KG, KZ, MD, RU, TJ, TM), European patent (AT, BE, CH, CY, DE, DK, ES, FI, FR, GB, GR, IE, IT, LU, MC, NL, PT, SE, TR), OAPI patent (BF, BJ, CF, CG, CI, CM, GA, GN, GW, ML, MR, NE, SN, TD, TG).

(71) Applicant and
(72) Inventor: SOLOMON, Neal, E. [US/US]; 901 Kingston Avenue, Piedmont, CA 94611 (US).

Published:
— With international search report.
— Before the expiration of the time limit for amending the claims and to be republished in the event of receipt of amendments.

(74) Agent: BEVERLY, Brian; Suite 2360, One Kaiser Plaza, Oakland, CA 94612 (US).

For two-letter codes and other abbreviations, refer to the "Guidance Notes on Codes and Abbreviations" appearing at the beginning of each regular issue of the PCT Gazette.

(81) Designated States (*national*): AE, AG, AL, AM, AT, AU, AZ, BA, BB, BG, BR, BY, BZ, CA, CH, CN, CR, CU, CZ,

(54) Title: CUSTOMER DEMAND-INITIATED SYSTEM AND METHOD FOR ON-LINE INFORMATION RETRIEVAL, INTERACTIVE NEGOTIATION, PROCUREMENT, AND EXCHANGE

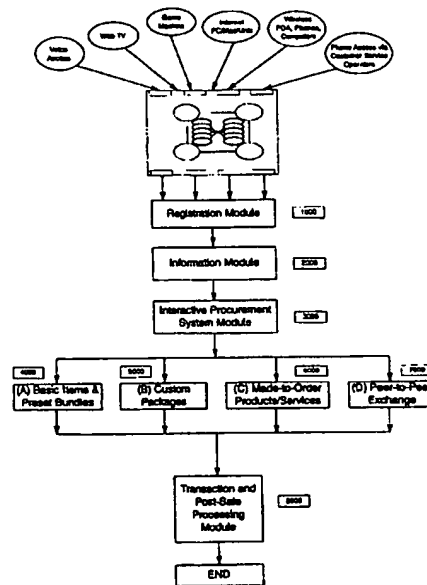

WO 01/33464 A1

(57) Abstract: A method and system are described for automated electronic-commerce procurement of services, products or bundles. The method provides a demand-based, information-specific negotiation process. Customers can initiate bidding with selected sellers in the system in a multivariate format based on numerous factors. Detailed information on services and products is available for the customer in order to make informed petitions. The system consists of four main modules: registration (1000), information (2000), procurement (3000), and transaction and post-sale processing (8000).

(12) INTERNATIONAL APPLICATION PUBLISHED UNDER THE PATENT COOPERATION TREATY (PCT)

(19) World Intellectual Property Organization
International Bureau



(43) International Publication Date
10 May 2001 (10.05.2001)

PCT

(10) International Publication Number
WO 01/33464 A1

(51) International Patent Classification⁷: G06F 17/60

(21) International Application Number: PCT/US00/30249

(22) International Filing Date:
1 November 2000 (01.11.2000)

(25) Filing Language: English

(26) Publication Language: English

(30) Priority Data:
60/162,932 1 November 1999 (01.11.1999) US

(71) Applicant and

(72) Inventor: SOLOMON, Neal, E. [US/US]; 901 Kingston Avenue, Piedmont, CA 94611 (US).

(74) Agent: BEVERLY, Brian; Suite 2360, One Kaiser Plaza, Oakland, CA 94612 (US).

(81) Designated States (national): AE, AG, AL, AM, AT, AU, AZ, BA, BB, BG, BR, BY, BZ, CA, CH, CN, CR, CU, CZ,

DE, DK, DM, DZ, EE, ES, FI, GB, GD, GE, GH, GM, HR, HU, ID, IL, IN, IS, JP, KE, KG, KP, KR, KZ, LC, LK, LR, LS, LT, LU, LV, MA, MD, MG, MK, MN, MW, MX, MZ, NO, NZ, PL, PT, RO, RU, SD, SE, SG, SI, SK, SL, TJ, TM, TR, TT, TZ, UA, UG, UZ, VN, YU, ZA, ZW.

(84) Designated States (regional): ARIPO patent (GH, GM, KE, LS, MW, MZ, SD, SL, SZ, TZ, UG, ZW), Eurasian patent (AM, AZ, BY, KG, KZ, MD, RU, TJ, TM), European patent (AT, BE, CH, CY, DE, DK, ES, FI, FR, GB, GR, IE, IT, LU, MC, NL, PT, SE, TR), OAPI patent (BF, BJ, CF, CG, CI, CM, GA, GN, GW, ML, MR, NE, SN, TD, TG).

Published:

- With international search report.
- Before the expiration of the time limit for amending the claims and to be republished in the event of receipt of amendments.

For two-letter codes and other abbreviations, refer to the "Guidance Notes on Codes and Abbreviations" appearing at the beginning of each regular issue of the PCT Gazette.

(54) Title: CUSTOMER DEMAND-INITIATED SYSTEM AND METHOD FOR ON-LINE INFORMATION RETRIEVAL, INTERACTIVE NEGOTIATION, PROCUREMENT, AND EXCHANGE

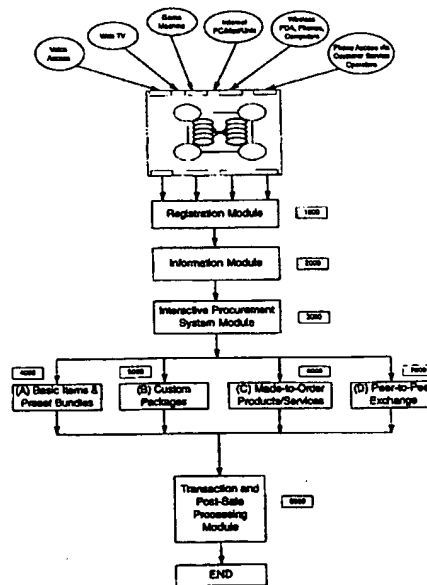

WO 01/33464 A1

(57) Abstract: A method and system are described for automated electronic-commerce procurement of services, products or bundles. The method provides a demand-based, information-specific negotiation process. Customers can initiate bidding with selected sellers in the system in a multivariate format based on numerous factors. Detailed information on services and products is available for the customer in order to make informed petitions. The system consists of four main modules: registration (1000), information (2000), procurement (3000), and transaction and post-sale processing (8000).

**CUSTOMER DEMAND-INITIATED SYSTEM AND METHOD
FOR ON-LINE INFORMATION RETRIEVAL,
INTERACTIVE NEGOTIATION, PROCUREMENT,
AND EXCHANGE**

5

BACKGROUND OF THE INVENTION

This application claims the benefit of U.S. Provisional application No. 60/162,932, filed November 1, 1999.

10

FIELD OF THE INVENTION

15

This invention relates to an improved electronic commerce procurement method and system which comprises a buyer seeking bids from sellers to sell identified products or services or bundles of product and service items. Information on product and service items is provided to facilitate the buyer's selection of products and services for procurement. Purchasing suggestions are made to the buyer based on demographic information learned about the buyer and the buyer's purchasing history. A negotiation process between buyers and sellers increases competition and reduces purchasing costs by increasing market efficiency.

20

In one embodiment of the invention, customer bid petitions are pooled for submission to sellers in a specific customer-defined time frame for increased purchasing leverage. In another embodiment, customized items are specified by customers in a negotiation process with vendors. In an additional embodiment, a customer can negotiate purchase of a product or service directly from any seller.

25

The Evolution of Electronic Commerce

30

The Internet affords an opportunity to extend a trend in production and marketing in which the customer is in control. "One to one" customized production and marketing allows a customer-centric approach that is the opposite of the mass production and distribution of products and services popular since the Industrial Revolution. One problem with mass production systems is the difficulty of accurately anticipating customer demand.

In the eighteenth century, products were made specifically for a customer. The Industrial Revolution created the opportunity to systematically mass-produce commodities by revolutionizing process-technology so that factories could be more efficient. Henry Ford's production model was perhaps the fullest expression of mass production. The Fordist system

was refined by the Japanese and by computer manufacturers such as Dell to create a system of Just In Time process development, in which a customer's order is efficiently produced in individual batches. This process technology transformation allowed a trend towards customization. But with the advent of the Internet, this trend can extend not only to
5 production and distribution but also to procurement and acquisition.

The Internet allows a rewriting of the rules of production, distribution and, especially, procurement. Electronic commerce allows interactivity, customization, customer-centric emphases, space-transcendence, demand-driven sales, and information-rich sales processes. The new economic rules mark a profound change that resembles a third industrial revolution
10 because taken together they represent a new way of doing business.

The very idea of "customer" suggests a customization process that the mass production systems of the twentieth century have overridden. A customized product or service is designed, ordered, manufactured and distributed to the needs of a specific customer. To provide custom service is a key goal of technologists and would confer advantages on
15 businesses.

What is needed is an electronic shopping system that emulates a method of shopping in general. In the general shopping situation, a customer selects several possible vendors based on information available from vendors and from third parties. The customer then negotiates the best deal in an interactive way based on features that go beyond price alone. Although
20 much of Internet-based commerce has been based on obtaining commodity products (and services) at the cheapest price, this is not necessarily the way people buy things in the off-line world. In many cases, a product is chosen for its quality, and then the best price is sought.

So far, however, no single system or combination of systems has been developed to deliver an effective commercial sales system. What is needed is an intuitive way to shop that
25 uses advanced technologies to simplify the shopping experience.

The present system presents a customer-centric shopping process that nevertheless satisfies optimal yield-management or risk-management for services and mass-customization for select products.

The challenges to the development of such a system so far have involved the inability
30 to precisely and systematically address: (1) seller-based multi-bidder competition, (2) multivariate dynamic interactive negotiation, (3) information-based procurement systematization, (4) demand-based customization, (5) adaptive systems that learn from data

analysis and synthesis, (6) emulation of an intuitive shopping process, (7) seamless aggregation of buyers for group discounts and (8) optimization of services management. The present invention addresses these problems in novel and nonobvious ways.

Discussion of the Prior Art

5 Shopping can roughly be described by five general process models. The first is simple catalog shopping, which involves viewing a catalog, selecting an item, and purchasing it. The second shopping process is a conditional purchase offer (CPO), which allows a customer to offer to purchase a product or service, but the offer has conditions attached to it which must be met by the seller. This model presents a moderate compromise wherein the vendor has a
10 limited range of opportunities to fulfill the customer's needs. In addition, the customer is limited to accepting a range of goods or services falling within the stated conditions.

The third type of shopping process is a simple reverse auction, in which the customer requests price bids on a specific product or service. Once made, a price bid from one of several vendors can be accepted or rejected by the customer. The fourth type of shopping
15 process is a request for quote (RFQ) or request for proposal (RFP). This is a sub-species of the reverse auction, and is most commonly used by governmental entities as a primary method of procurement. In an RFQ setting, the customer provides specifics about a product or service that it desires to acquire, and puts those specifications out as a request for a bid. Price quotes received from various vendors can be accepted or rejected by the customer. Price
20 alone is the primary criterion, which may override all other factors and tends to suppress all but the cheapest items. The fifth main shopping process involves aggregation, in which a central system gathers orders from multiple customers until a certain minimum number of orders are collected. The aggregated orders are presented to a vendor or vendors with the increased purchasing power of pooled buyers to receive wholesale product discounts.

25 As implemented, the above general shopping models are simplistic and passive. In all models, the customer has limited information about services, products, and their vendors, and must proceed with price as the sole criterion for deciding whether to purchase. Essentially, these shopping models create a take-it-or-leave-it situation for most customers.

In the rush to electronic commerce, numerous attempts have been made to apply these
30 commonly known shopping models to on-line settings. One prominent trend in e-commerce has been to disintermediate (i.e., to remove the middle man, generally the wholesale layer of distribution transactions), leaving manufacturers, vendors, underwriters, and service providers

to sell directly to customers. With experience, the pendulum has swung the other way, with a trend to introduce an intermediate agency in the form of an exchange that provides a neutral forum for the evaluation and selection of goods or services. The concept of a "metamediary" that has evolved from this trend posits that, rather than having multiple layers of distribution, 5 manufacturers, underwriters, or service providers, a single metamediary can provide all needed exchange services between the vendor and the customer. The goal is to provide the customer with a trusted agent in which reliance can be placed to provide neutral information and transaction processing capabilities, and, at the same time, a neutral forum for vendors to compete on an even playing field. The ideal metamediary is thus neutral to both the buyer and 10 the seller. Metamediaries to date have mostly been focused on specific vertical specialized categories, such as sales of travel (e.g., the Expedia and Cheaptickets websites), telecommunications services (e.g., Simplexity), mortgage brokerage services (e.g., Lending-tree.com), and small business services (Onvia and Works.com, for example).

The Internet affords the opportunity to extend a trend in production and marketing in 15 which the customer is in control. Systems of "one to one" customized production and marketing allow a customer-centric approach that is a dramatic improvement relative to the commodity-type mass-production and distribution models popular up to the present time.

A number of revolutionary events are occurring simultaneously in commerce. The 20 advent of the Internet and electronic commerce are presenting a convergence of these events. The first change is the ability to provide "yield management" or "revenue management" systems in which optimal pricing can be established for selected services. This pricing model, referred to as "non-linear" or "dynamic" pricing, is used in the telecommunications and travel industries to calibrate peak and off-peak usage and to maximize revenue for carriers and value for customers. "Risk management" systems are also employed by insurance and banking 25 companies in order to classify customers in categories of relative risk, thereby maximizing revenue while at the same time controlling the risk of default or catastrophe.

Another major commercial change is the emergence of "mass customization" in which 30 products can be ordered on demand, manufactured according to a customer's unique specifications and immediately shipped and delivered. A computer can, for example, be ordered according to specifications and delivered within a few days from a remote factory at a minimal cost. These manufacturing approaches exploit just-in-time process technologies as

well as the development of real-time information technologies to accurately estimate and forecast demand.

While these new commercial systems represent a significant step in the direction of empowering the customer, e-commerce systems as implemented provide inadequate
5 information about prices, vendor reputation, and product or service quality. The potential advantages of truly interactive automated ordering in the e-commerce environment has yet to be adequately realized.

A number of efforts have been made to bring electronic commerce to fruition. Shopping sales systems are described in Chelliah, U.S. Patent No. 5,710,887; Payne, U.S.
10 Patent No. 5,909,492; Suzuki, U.S. Patent No. 5,890,139; Harrington, U.S. Patent No. 5,895,454; Blinn, U.S. Patent No. 5,897,622; Wilf, U.S. Patent No. 5,899,980; Payne, U.S. Patent No. 5,715,314; Carter, U.S. Patent No. 5,926,798; Suzuki, U.S. Patent No. 5,946,665; Odom, U.S. Patent No. 6,058,379; and McDonough, U.S. Patent No. 6,070,142. (Also, Barnes, et al., PCT/US98/16517, U.S.App. 08/949,182; Groult, et al., PCT/US00/06535,
15 U.S. App. 09/266,246; Tolz, PCT/US00/01852, U.S. App. 60/117,232; Facciorusso, et al., PCT/IB99/01613; Ritter, PCT/CH98/00276; Walker, et al., PCT/US99/34842, U.S. App. 09/205,824 and 09/224,907.) Odom discloses a real-time networked exchange with seller-specified exchange parameters and interactive seller participation. Basic information on the commodity or item for sale is made available to the buyer. A negotiation process is described
20 between buyer and seller directed primarily to pricing. Most of these sales systems involve a customer using a network-accessible computer, reviewing a catalog of products, making a selection, and purchasing the item. None of these prior art systems allow the buyer to demand information about products, services, or vendors.

Online information systems are disclosed in Suzuki, U.S. Patent No. 5,890,139,
25 Carter, U.S. Patent No. 5,926,798, Hartnett, U.S. Patent No. 6,064,971, Woolston, U.S. Patent No. 6,085,176, and Roberts, U.S. Patent No. 6,101,486. (Also, Sloane, et al., PCT/US00/01260, U.S.App. 09/233,825) Hartnett discloses a complex learning system. Woolston 6,085,176 discloses a method and apparatus for using search agents to search a plurality of markets to create a computerized market for used and collectible goods and
30 allowing the purchaser of a good to speculate on the purchased goods. These systems provide information retrieval methods only and do not involve a practical procurement component.

Collaborative filtering techniques are disclosed in Sheena, U.S. Patent No. 6,049,777, Chislenko, U.S. Patent No. 6,092,049, and Linden, et al., PCT/US99/20974 (U.S. Application No. 09/157,198). These prior art approaches use relatively simple item-based collaborative filtering techniques, in which a customer can cross-reference similar items based on an analysis of a pool of customers that have purchased similar items. None of the prior art extends to consideration of other factors useful in filtering customers' procurement history to learn enough to make meaningful procurement suggestions.

Reverse auctions are disclosed in Fisher, U.S. Patent No. 5,835,896; Godin, U.S. Patent No. 5,890,138; Zandi, U.S. Patent No. 5,966,699; Barzilai, U.S. Patent No. 6,012,045; and Odom, U.S. Patent No. 6,058,379. Gindlesperger (PCT/US99/28187, U.S.App. 60/110248) describes a system for buyer-requested products and services from vendors organized in a registry. Barzilai discloses a computer-based electronic bid, auction, and sale system wherein a virtual showroom is accessible by customers' computers, which display consumer goods and services and information regarding the commonly available selling price for each product and service. Zandi discloses a system and method for conducting a loan auction over a computer network. Fisher and Zandi focus on the financial services industry. All of the prior art reverse auction approaches are unilateral, in that the seller has all of the bidding power. None of the prior art reverse auctions provide a true interactivity component or takes advantage of the ability to extend the reverse auction into a bilateral or multilateral negotiation.

Negotiation in the e-commerce setting is disclosed in Kennedy, U.S. Patent No. 6,055,519, Solomon, U.S. Patent No. 6,035,288, Odom, U.S. Patent No. 6,058,379, and Conklin, U.S. Patent No. 6,141,653. Solomon discloses an interactive computer-implemented system and method for negotiating the sale of goods or services using a simulated human merchant having predefined behavioral attributes. Conklin uses multivariate factors of negotiation directed primarily to transaction terms and conditions such as shipping date and payment methods. Odom lacks sufficient interactivity to equalize the bargaining ability of the buyer. These prior art negotiation models are primarily unilateral, empowering the product sellers. (See also international apps: Lustig, et al., PCT/US99/23260 (U.S. App. 60/103,076); Crawford, et al., PCT/US99/27814 (U.S. App. 09/197,655); Miller, et al., PCT/US99/21934 (U.S. App. 09/399,753); Sloo, PCT/US96/11566 (U.S. App. 08/503,718); Bigus, et al., PCT/US98/04878 (U.S. App. 08/821,935); Vulkan, PCT/GB99/03528; Tavor, et al.,

PCT/US00/01667 (U.S. Apps. 09/236,098 and 09/317,956); and Ojha, et al.,
PCT/US00/01523 (U.S. App. 09/265,511)).

Rickard, U.S. Patent No. 6,112,189, discloses a method and apparatus for automating negotiations between parties by calculating a mutual satisfaction between negotiating parties and maximizing their mutual satisfaction over a range of decision variables without requiring the parties to identify themselves and their positions to each other.

Peckover, U.S. Patent No. 6,119,101, discloses a system for electronic commerce using computer agents that represent consumers and vendors in a virtual marketplace, wherein the identity of the consumer can be kept concealed. The proxy agents are capable of creating decision agents that shop for products and assist consumers in comparing and ranking products.

Customization is disclosed in Rose, U.S. Patent No. 5,930,769, and Ulwick, U.S. Patent No. 6,085,165. Rose applies to custom fashion purchases, such as custom suits. Ulwick teaches the use of customization as a method to buy products. Ulwick discloses a computer system for customization that expands an individual's ability to process a large amount of information and make complex personal and business decisions. Neither of these prior art customization applications applies customization to a broad range of customizable products and services, or teaches how to practically administer customization to a goods and services procurement system that involves negotiation.

Several Walker patents, U.S. Patent No. 5,794,207; U.S. Patent No. 5,797,127; and U.S. Patent No. 5,897,620, disclose methods and apparatus for administering conditional purchase offers (CPOs). The Walker patents focus on travel and memorabilia, wherein a customer submits a demand at a set price for a product or service, the demand delimited by a set of contingencies which must be met by one of various affiliated vendors participating in the process. The CPO prior art requires the customer, within the limits of the conditions placed on a demand, to submit to the purchase process. There is no real interaction or negotiation between the buyer and sellers. Though they are called "demand-based" systems, they offer few choices and nominal quality options to customers.

Sales systems involving finance are disclosed in Greco, U.S. Patent No. 5,809,478, Ogram, U.S. Patent No. 5,822,737, Zeannah, U.S. Patent No. 5,933,816, Zandi, U.S. Patent No. 966,699, and Minton, U.S. Patent No. 6,014,643. The financial sales model applies to securities exchange for automation of the online sale of commodities, equities, debt, or loans.

Typically, one seller is involved with several buyers of shares of a stock or a commodity. In the case of consumer loans, on the other hand, a customer may request loan approval from lenders in a blind process similar to a CPO. A sales system involving telecommunications services is disclosed in Lickiss, U.S. Patent No. 6104798. Each of these prior art sales systems resembles unilateral catalog sales approaches.

Van Horn, U.S. Patent No. 6,047,266 and Halbert, U.S. Patent No. 6,101,484 disclose aggregation systems in which customers are grouped together to create a wholesale product buying capability. (Also Pallakoff, PCT/US99/18879, U.S.App. 60/097,932 and 60/097,933; Reddi, PCT/US00/01457, U.S. App. 09/346,783; and Alon, PCT/US00/03164, U.S. App. 60/119,220; Sharfman, PCT/US00/02830, U.S.App. 09/390,015). In these systems, individual customers lack control even though they seek maximum price benefits.

International PCT Application PCT/US00/01523, to Nextag.com, Inc., discloses methods and apparatus for facilitating a transaction for consumer products between a buyer and sellers via the Internet. Vendor-provided product information resident in a database relating to a plurality of products meeting buyer-specified criteria is presented via the Internet. A bid from the buyer to a seller is presented according to response criteria specified by the seller. If the seller's response is an acceptance, consummation of the bidding process is facilitated. If the vendor's bid response to the first buyer bid is a counteroffer, a new price bid in response to the counteroffer is enabled, and either accepted or rejected by the buyer.

None of the prior art (a) takes full advantage of the opportunity to establish a procurement system for goods or services that provides detailed information on vendors, products, and service items, (b) places the buyer on an equal footing by allowing demand-based multilateral simultaneous negotiations with vendors based on item features or quality as well as on price, or (c) combines the flexibility of buyer-driven negotiation with the purchasing power of a group of customers for increased bargaining strength.

SUMMARY OF THE INVENTION

A method and system are described for automated e-commerce procurement of services, products or bundles. The method is demand-based, a buyer's request for information or for bids for a product or service initiating use of the system; buyers are enabled and encouraged to make requests to sellers and to the system in a multivariate format based not merely on price but on numerous factors including item features, quality, and vendor reputation, distinguishing the method and system from a disintermediated commerce model in

which buyers are drawn to a site simply to buy from a merchant's catalog. Detailed information on services and products is available for the customer, and transparent (or non-transparent) negotiating processes between the customer and multiple sellers create competition, forcing item prices lower. The system consists of four main modules:
5 registration (1000), information (2000), procurement (3000 – 7000) and transaction and post-sale processing (8000).

The registration module has modes for new or existing customers. For new customers, the registration process consists of selecting a language option and user ID/Password. The new customers are also informed about how the system works (through
10 FAQ, customer service interaction or messaging systems) as well as about the privacy and use policies. Referral credits and targeted promotions are also provided.

In each new use of the system, existing customers are provided with access to a presentation manager that recommends products or services, promotions and calendar information as well as an opportunity to modify the customer's system preferences.

15 After registration, the customer proceeds to the information module, where information and analysis about products, services or bundles are made available in several different ways. Customers can request information (a) about a product or service in a simple search, (b) about a vendor, or (c) about products or services offered by a vendor. A customer can also search a hierarchical database of goods and services, or use item-specific shop bots
20 (intelligent software agents) to peruse outside vendor items. Once an item is selected, a customer can obtain detailed information on the item provided by the vendor or through third party information. Data on the selected item is analyzed and synthesized for presentation in a number of customer-friendly formats including editorial retailing information such as opinions and ratings about vendors from prior customer experiences, articles by third parties, e.g.,
25 reviews of vendors or items, and comparison information. The latter is presented in spreadsheet format by price, pricing plans for services, or other features specified by the customer. Several types of collaborative filtering approaches are used to help the customer select an appropriate item, including region-based, feature-based, profile-based, quality-based, quantity-based, popularity-based, and price-based as well as item-based filtering techniques.
30 Intelligent software agents known as Shop Bots perform searches for the system in the background. Once a product or service is identified, the customer either proceeds to the

procurement module (3000 - 7000) or may simply buy the product or service at a preset price by proceeding directly to the transaction and post-sale processing module (8000).

There are eleven major categories of products, services or bundles a customer may select before using the procurement module. These categories are (1) yield management
5 services (telecom, travel and energy services), (2) risk management services (banking, insurance and mutual funds), (3) business services (technology and corporate consulting and professional services), (4) preset bundles (specified telecom application services, basic telecom service combinations and finance bundles), (5) customized products (computers, computer software, telecom equipment, office equipment and high-end consumer electronic
10 equipment), (6) industrial parts and sub-assemblies, (7) made-to-order products, (8) customized services, (9) miscellaneous and used products, (10) small business services, and (11) personnel and management recruitment services. Items in each of these categories are purchased using one or more parts of the procurement process discussed below.

The procurement module consists of four particular modules. Module A provides a
15 process for the procurement of specific items of products and services as well as preset bundles of products and/or vendor services; Module B provides a process for the procurement of customized bundles of multiple items of products and/or vendor services; Module C provides a process for the procurement of made-to-order products and vendor services; and Module D provides a procurement process for a customer to buy a product or service directly
20 from any seller. Preset bundles (Module A) are product and service items sold in groupings established by the vendor. A bundle may include product items only, service items only, or both product and service items. Customized bundles (Module B) are product and service items already available on the market sold as a group to meet the customer's needs. Made-to-order products (Module C) are built and services arranged according to customer
25 specifications.

Under the system, bid requests may be constructed and processed using a variety of tools. Requests are multivariate as discussed above, but also may be simultaneously presented to a plurality of sellers for responsive bidding. Each request-bid process between a customer and an individual vendor may be paused for resumption at a later date (within a limited time
30 frame). And the system encourages the buyer to winnow the number of vendors for a more focused negotiation.

Customers may also insert in a request a condition that any resulting bid include options that confer specific rights to vendors or provide specific opportunities for customers. Bids may include a simple option agreement or an option with an evaporating offer containing a front-end inducement to encourage the customer to accept the bid within a specified time.

5 On the other hand, vendors have the right to sell an item to another customer within a specified time if they pay a pre-agreed penalty.

In Module A, a customer enters information (e.g., item features or a description of the item) about an item of interest, e.g., a product, service, preset bundle of products and services, or a specific bundle of products or services. The customer then selects at least four
10 vendors from a list of appropriate vendors generated by the system. The system communicates with the vendors using Extensible Markup Language (XML) software to obtain information on the item request. Vendors registered with the UDDI business registry are favored. Each vendor responds with a price quote, again by using XML software. The system receives the vendors' bids and formats them for inclusion in a spreadsheet or database
15 comparison chart. The customer then selects at least two best options from the list of at least four.

The customer requests an initial price bid on the item from the selected ("finalist") vendors. The finalist vendors then have the option to respond to the request by either accepting it or providing a first vendor counter-offer. The counter-offer may be based on price
20 or alternative features. The customer may accept one of the vendors' counter-offers and proceed to transaction and post-sale processing, or the customer may modify the standing request based on price or alternative features. The customer may also go back one or more steps in the process, and select alternative vendors from which to request price bids. The system is designed to be flexible for the customer and neutral for the vendor.

25 In Module B, a customer enters information about a combination of appropriate products, services or bundles, and chooses two vendors for each requested item. A time duration is specified for how long the customer is willing to wait to hear back from the vendors, whether immediately, one day, or longer. Orders from a multitude of customers are pooled together according to the type of item and the requested response time. This pooling
30 of order requests is then sent to the indicated vendors for price information requests by using XML software. Vendors registered with the UDDI business registry are favored. If a

specific vendor gets several similar requests within a limited time frame, it will be encouraged to provide discount pricing based on volume sales.

In one embodiment, if the vendor does not provide an item as promised within the specified time, the vendor may be penalized, e.g., required to pay a preset fee to the customer.
5 This option contract component allows the vendor to sell the item at more than the arranged price plus the penalty, if arranged before the deadline.

In each specific item-request vendor interaction, the process is similar. The customer either accepts the bid price from one vendor and the item is sent to transaction and post-sale processing, or the customer counters to one or both vendors on the basis of features, quality
10 or price. The vendor then may accept the counter-offer and proceed to acquire the item or the vendor may counter the customer's counter proposal for final customer acceptance. The customer then has the opportunity to modify the request a final time.

Items that are selected by the customer at the final specified vendor price are then reassembled into a unique package based on accepted vendor offers of the original group of
15 items. Because this part of the system involves several items, the customer must confirm the total order before proceeding to transaction and post-sale processing.

Module C covers a distinctive set of products and services that are specifically made-to-order for the customer involving item categories 7 and 8 above. After selecting a specific product or service item, the customer must enter very particular information on the detailed
20 specifications of the item, which may include information on him/her or on the customer's business operation.

The customer selects at least four vendors that can supply the product or service from a list of appropriate vendors. The system communicates the customer request information by using XML software and obtains initial vendor bids. As above, vendors registered with the
25 UDDI business registry are favored. The customer chooses at least two vendors with which to negotiate from the initial four based on the bids. In the event several bid requests for similar items are received at about the same time, or if a single request is for two or more of the same item, the request may demand or the seller's bid may offer a reduced price per item. The customer can accept one bid or can make one or more counter bids on the basis of item
30 features, quality or price. One vendor may accept the counter bid or one or both vendors may provide a counter bid to the customer's initial counter bid. If neither counter-bid is accepted, the customer has the opportunity to modify the order request. If the customer accepts a

vendor's final offer, then the order is assembled. Once the customer confirms the final order, he or she can proceed to the transaction and post-sale processing module.

Module D provides a peer-to-peer exchange for single-instance transactions, such as non-commercial acquisitions of used items. In the peer-to-peer module, the buyer initially proceeds by selecting a product or service item. The customer may either describe a set of features desired in an item, or select an item from categories 1, 5, 9, 10, or 11, which contain items appropriate for the peer-to-peer module. If features are entered, the system searches for items registered by sellers on the system for responsiveness to the request. Whether by a feature-based search of the system's database, or by selection from the system's categories of items, a list of sellers is generated. The customer then has the option of refining the selection by refining the request with additional or more exactly described features. The system responds with a narrowed list of sellers, each of which is associated with an item and an ask price. The buyer may elect to purchase one of the items or provide a counteroffer to the price and enter into a negotiation phase with one or more sellers. If the buyer and a seller agree on a price, negotiations with other sellers are immediately terminated, and the transaction is forwarded to the transaction and post-sale processing module for completion. The actual negotiation process may occur outside the system directly between buyer and seller.

A customer accountability rating system allows sellers to view the reputation of a customer who has submitted a request for bids. The seller uses the customer accountability rating to make decisions about whether to submit a bid and about the content of the bid. The accountability rating system tracks the number of experiences the customer has with the system, the number of successful transactions, the number of unsuccessful transactions, and vendor feedback. Each customer is given an numerical rating representing the level of risk presented by the customer to the seller based on the customer's accountability rating.

The transaction and post-sale processing module processes the customer order. The customer has the option of having the transaction processed directly by the vendor or by the system. New customers will be required to provide information about themselves, such as name, address, phone, and e-mail address. Business customers may be required to provide additional information, such as position, company name, etc. Customer identity and credit rating information must be verified., as appropriate. Customers are provided with several main payment options, including check, credit card, phone-bill-pay, or electronic payment. They may also request and obtain limited credit to facilitate the transaction, request extended

service warranties, and donate up to 1 percent of the purchase price, up to \$50 per transaction, to charity. Once a payment method is selected, the payment is confirmed. Customers who have already used the system can elect to use their previous payment method, a new payment method, or charge the sale to their account if appropriate. Once payment is confirmed, an invoice is created and sent to the appropriate vendors, and the invoice is then confirmed by the vendor. A contract is created and a digital signature is obtained from the customer. The order is then cleared, the vendor is paid, and the order is tracked up to the point of fulfillment via e-mail alerts.

In post-sale processing, the customer creates a personalized presentation manager. Information from prior transactions is entered into the presentation manager so that it builds a customer profile and develops a calendar to track items. After the sale, information and opinions are requested about the items, the vendors, and the experience. The customer profile information is analyzed to provide new product suggestions and target appropriate ads. Aggregate information from numerous customers allows the system to provide accurate detailed recommendations and predictions based on the application of collaborative filtering technologies. The information thus obtained is then used in the registration and information modules to analyze general customer patterns and to make procurement suggestions useful to the customer. The system in effect learns from earlier customer experiences to optimize the customer's future uses of the system.

Advantages of the Invention

As can readily be appreciated, a customer demand-initiated shopping system described by the invention yields numerous advantages. First, the system is initiated by customer demands, by requests which solicit bids from sellers. Accordingly, a marketplace is established and defined by the nature and number of customer requests.

A second advantage is that customer requests and seller bids are multivariate in nature. Requests are made, and bids are provided, not merely on price alone, but based on a panoply of available factors, including item quality, item features, item popularity, delivery time, place of origin of the item or service, vendor reputation, customer ratings, method of payment, customer profile data, and customer accountability rating scores, rather than transaction delivery terms alone.

A third benefit of the invention is that the request-bidding process proceeds multilaterally between a customer and up to several sellers. This is accomplished by enabling

a customer to either simultaneously or sequentially provide a request to multiple vendors for responsive bids. The negotiation between a customer and any one individual vendor can be paused for later resumption without penalty. This allows the customer, for example, to pause negotiations with all except one vendor for focused attention. The combination of
5 simultaneous and sequential negotiation processes allows each customer to control the unique dynamics of the bidding session.

A fourth advantage of the invention is that the system provides detailed information on items identified by a customer. The system provides not only information contained in the system memory, but information is retrieved from third-party information vendors and other
10 sources by intelligent search agents, including shop bots. The system uses data analysis and synthesis processes to organize information about sellers, customers, and items.

A fifth advantage is in the flexibility of choices available for presentation of the information to the customer. Pricing or other information for products or pricing plans for services can be presented in a spreadsheet format. Alternatively, the customer may review
15 opinions and ratings about vendors and their items from for prior customer experiences, review third-party articles, item reviews by vendors, or third-party reviews of vendors or items, or peruse a wide variety of other information in spreadsheet format, including item quality, features, or delivery time, vendor reputation, product or service reputation, and terms of payment.

A sixth advantage is the customer demand-initiated method of procurement of
20 products, services, and bundles of services and/or products.

A seventh advantage is the ability to include option contracts that obligate vendors to provide items in a specific time and penalize them if they do not, in a request or responsive bid. This advantage is supplemented by the availability of evaporating offers, which reward
25 customers by providing benefits for early acceptance.

An eighth advantage is implemented by encouraging requesting customers to winnow their initial list of sellers to a smaller number for more focused subsequent negotiations. In the Basic Items Module, buyers are encouraged to narrow their choices to four quarter-finalists, and then to winnow that list to two semi-finalists with which to negotiate, before focusing on
30 interacting with a single vendor. Customers are also allowed access to the bidding process of other customers, contingent upon each granting access to that customer's negotiations.

A ninth advantage is the dynamic pricing made possible by the nature of the negotiation process. This is accomplished de facto by the iterative process of the negotiation system. Such a dynamic pricing sales system is well suited to selling not only the newest as well as trailing edge technology products, but also yields management and risk management services in which pricing is contingent on high peak or off-peak usage, or on high risk or low risk customer profiles.

A tenth advantage of the system is that it combines products and services into customer-selected multiple-item bundles, rather than simply limiting choices to product combination packages.

It is therefore a primary object of the invention to provide a customer demand-initiated procurement system for product and service items which solves the above and other problems in the prior art.

It is a further object of the invention to provide an improved shopping method and system in which detailed information on product items and service items is provided to the customer upon request.

It is a still further object of the invention to provide an improved shopping method and system in which procurement suggestions are made to the customer based on a customer profile maintained by the system.

It is another object of the invention to provide an improved shopping method and system in which a customer may conduct multivariate, simultaneous negotiations with a plurality of vendors, wherein the negotiations with any vendor can be conducted in a plurality of time-separated sessions.

It is a still further object of the invention to provide an improved shopping system and method which implements an automated on-line method and system reflecting the intuitive method of shopping commonly used by most persons.

It is another object of the invention to provide an improved shopping method and system for procuring individual product and service items, preestablished bundles of product and service items, multiple-item bundles of product and service items, made-to-order bundles of product and service items, and a peer-to-peer exchange module for single-instance sales of products and services from any seller.

BRIEF DESCRIPTION OF THE ILLUSTRATIONS

Figure 1 is a schematic diagram of a simple catalog shopping process.

Figure 2 is a schematic diagram of a simple reverse auction process.

Figure 3 is a schematic diagram of a simple conditional purchase offer.

Figure 4 is a schematic diagram of a simple request for quote process.

Figure 5 is a schematic diagram of a simple order aggregation process.

5 Figure 6 is a schematic diagram of a simple option contract.

Figure 7 is a schematic diagram of a system overview of customer demand-initiated shopping apparatus according to the invention.

Figure 8 is a schematic diagram of an abstract of the shopping system of Figure 7.

10 Figures 9a and 9b are a schematic diagram of the registration model of the shopping system of Figure 8.

Figures 10a and 10b are a schematic diagram of the information module of the shopping system of Figure 8.

Figures 11a - 11f are a schematic diagram of a typological chart of products, services, and bundles which can be purchased using the shopping system of Figure 8.

15 Figure 12 is a schematic diagram of the basic configuration of the interactive procurement module of the shopping system of Figure 8.

Figures 13a and 13b are a schematic diagram of the basic items and preset bundles procurement process of the procurement module of Figure 12.

20 Figures 14a and 14b are a schematic diagram of the custom packages procurement process of the procurement module of Figure 12.

Figures 15a and 15b are a schematic diagram of the made-to-order customized products and services procurement process of the procurement module of Figure 12.

Figures 16a - 16c are a schematic diagram of the peer-to-peer exchange process of the procurement module of Figure 12.

25 Figures 17a - 17d are a schematic diagram of the transaction and post-sale processing module of the procurement system of Figure 8.

Figure 18 is a schematic diagram of the customer service module of the procurement system of Figure 8.

30 Figures 19a - 19g are examples of Web site page views implementing portions of the information module of Figures 10a and 10b.

Figures 20a - 20i are examples of Web site page views implementing portions of the negotiation of Figure 12.

Figure 21 is an example of a Web site page views implementing the initial view of transaction processing described in Figures 17a-17d.

Detailed Description of the Illustrated Embodiment

5 An improved automated e-commerce procurement system and method are described in detail as illustrated in the schematic diagrams.

Figures 1-6 illustrate well-known prior art shopping models. A simple catalog shopping process is shown in Figure 1, wherein the customer peruses a catalog (100), selects an item (110), and proceeds to process the transaction (120). This well-known shopping method has been popularized on most commercial web sites as the accepted shopping module.

10 A simple reverse auction is shown in Figure 2. In response to a customer's request for bids (200) on a specific product, a plurality of vendors each provide to the customer a bid (210) containing an asking price for the product. The customer may accept a bid, reject all bids, or make a counter-bid (220) to a specific vendor. If the customer accepts a vendor's bid, the transaction is processed to completion (230). If the customer rejects all vendors' bids, the process may begin again. If the customer counter-bids (240) to a single vendor, that vendor may accept, reject, or counter (250). If the vendor rejects the customer's counter-bid, the process can begin again. If a vendor accepts a customer's counter-bid, the transaction is processed to completion.

20 The simple conditional purchase offer illustrated in Figure 3 is used in the well-known Priceline web site. The customer makes a conditional purchase offer – an offer having conditions attached to it – by, for example, specifying a requested item and committing to accept the item if any vendor meets the customer's specified price (300). The bid is reviewed by vendors (310), an acceptance is issued by one of the vendors determined by operating rules (320), and the transaction is processed (330).

25 A simple request for quote (RFQ) process is illustrated in Figure 4. The RFQ procedure is most commonly used by government entities for purchasing. The customer, e.g., a government entity, selects a product (400) and sets forth specifics in a price request (410). Prospective selected vendors receive the request (420). The vendors are usually undesignated, especially if the bid is public. The customer then receives quotes from one or more vendors (430) and thereafter accepts one of the bids (440). The transaction is then
30 processed to completion (450).

A simple aggregation model is illustrated in Figure 5. One example of this shopping model can be found at the Mercata web site. In the aggregation model, a plurality of customers each select a specific product (500). The customers' orders are aggregated for presentation to the vendor, which provides a better unit price if an increased number of orders are presented within a specific time frame (510). At the end of the specified time frame, the vendor indicates the product price, which is accepted by the customer (520) and passed to transaction processing for completion (530).

Figure 6 illustrates a common option contract process. Initially, the customer selects an item at a price offered by the seller, the sale to be closed at a specified future time deadline (600). Before the time deadline, the vendor waits for a better price (610) and, if offered a higher price, then the vendor may sell to another buyer (620). If the vendor sells to the other buyer at the higher price, the buyer must provide the original customer with a pre-agreed fee denominated as a penalty for not selling the item at the original price at the designated deadline (630). If no higher price is presented to the vendor during the waiting period, the vendor then sells the item to the customer at the originally agreed price (640).

An improved procurement system is described according to the schematics as follows:

1000 (Registration Module)

2000 (Information Module)

3000 (Interactive Procurement System)

20 4000 (3A) Basic Items & Preset Bundles

5000 (3B) Custom Packages

6000 (3C) Made-to-Order Products/Services

7000 (3D) Peer-to-Peer Exchange

8000 Transaction and Post-Sale Processing

25 Referring generally to Fig. 7, the system consists of the following components:

a) Multiple interlinked servers with multiple processors; network interfaces (e.g. wired Internet, wireless data, satellite links, and web TV) including links to purchaser computer nodes and vendor computer nodes, one or more computer memories; distributed storage area networks, and provisions for system and operational redundancies, reliability and backup.

b) Software to operate the system, including intelligent software agents, such as shopping bots, that provide intelligent analytical recommendations based upon various

collaborative filtering techniques, maintain customer profiles, and search for and collect specific data.

c) Firewalls and/or proxy servers, to maintain high-level integrity of the data, including private customer information.

5 Customer / User: These terms are used interchangeably throughout this description to refer to any person who accesses the system to use it for business purposes.

It is assumed that users will be accessing the system via the world wide web or a local area network. However, the system is accessible via other well known electronic communication networks, including a cable television network, satellite system, and wireless
10 telephone systems.

1. Registration Module (1000)

As shown in Fig. 9a, upon entry (1010) to the system, the customer decides how to interact with the system. New customers are directed into basic registration. Existing customers enter a user name and password for verification, to bypass registration.

15 New customers are prompted (1020) to select the language they prefer the system to use during their sessions, or accept the default language. (English would be the default language in English-speaking countries.) This language preference is saved as part of the customer's profile and re-applied automatically whenever that customer logs onto the system.

The system presents an appropriate welcome message (1030) in the selected language,
20 and prompts the customer to choose their next action.

The customer may proceed through a brief registration process (1040), or choose to proceed to the customer service module (1050 -- 1080) to get more information about the system before registering.

The customer service module is shown in Fig. 18. Customer service provides
25 information about the system and how it can be used to benefit the customer's business. Referring back to Fig. 9a, the system provides the customer a choice of three optional modalities: FAQ (1060), Tour (1070), or Messaging (1080).

The FAQ (1060) is a collection of frequently asked questions and their answers that reveal the strengths and the versatility of the system components, procedures, applicability,
30 and benefits.

The Tour (1070) provides a tutorial that shows a site map of the system and its component areas, and guides the customer through a series of simple procedures used to

conduct business transactions or receive information on product and service items and bundles and custom packages of selected product and service items.

Messaging (1080) is where customers are enabled in a variety of ways (e.g., phone, e-mail, or interactive video) to contact live agents to seek further information and assistance.

5 Existing customers, who are already registered with a user name and password are routed to the Presentation Manager (1090), an intelligent software agent that presents the customer with several options, including access to Customer Service. Customers may update their account information or preferences, change their password, access or modify their calendar, or personalize their account by customizing the types of features and service they want to receive.

10

Once the customer leaves the Customer Service Department, the system implements a collaborative filtering (1110) function which may be item-based, region-based, profile-based, quantity-based, price-based, or quality-based.

15

Customer data captured by the system is analyzed, and recommendations are prepared based on specific requested cross-references. Suggestions can thus be made based on items previously chosen and on customer profiles. Consequently, a customer can be referred to other items acquired by other customers with similar profiles and/or customers who have chosen similar items.

20

The system next employs intelligent software agents (1120) to present the customer with special offers and targeted promotions on appropriate items based on information learned from creating the customer's profile during previous sessions on the system.

The system then presents a basic registration template (1130) to new customers.

25

Once the customer enters basic registration information (1140), such as a user name and password, the system discloses the Non-Intrusion Directive -- customers will only be asked to provide the minimum amount of information that is necessary to carry out the requests of the customer. More information may be requested if the user utilizes system services and products that require more information. (For example, if the user asks the system for recommendations, the system will prompt the user for more information regarding their preferences, so that an intelligent software agent or a shop bot may make appropriate recommendations. Likewise, if the user requests credit for leasing or financing, the system will prompt the customer to fill out a credit application.)

30

The system determines whether the basic registration process is complete (1150) and loops back (1130) to obtain user information until the basic registration is completed.

At (1160) the system queries the customer regarding who referred them to the system. If an existing customer made the referral, then a "thank you" e-mail message is sent to the referring customer, and referral credits are applied to the referring customer's account.

To complete registration, the system presents the "Terms of Use" and privacy policies (1170), and proceeds to the Information Module (2000).

2. Information Module (2000)

As shown in Fig. 10a, the user selects (2010) the type of query wanted. At 2020 the user may opt to create a charge account, track his or her account, customize the user's account, e.g., modify user preferences, investigate a special sale such as a cross marketing opportunity, or contact (2030) Customer Service.

If at 2010 the user chooses to continue an old transaction, the system will present (2040) all previous queries and prior orders saved by that customer.

The user then selects at 2050 the saved order or query to access.

The user may then edit (2130) a prior order, essentially creating a current order, or further pursue an old inquiry.

If the customer confirms an old order for fulfillment, the system then jumps to the procurement process beginning at 4130 (Fig. 14).

Referring back to 2050, rather than pursue an old order or inquiry, the user may instead decide to create a new query by initiating a request for information. The system then presents options to the user to enter features desired in an item or to select an item from a provided typological index of product and service items. Accordingly, the user is prompted (2060) to describe a service, product or bundle or select one so that the system may search the database for an appropriate item.

If the user elects to describe (2070) an item, the system prompts user to enter a description of the product or service item in natural language form. An intelligent software agent parses the natural language request and searches (2080) the system's database for matching items. If a match is not found in the database, the system will pass the search to a shopping robot (intelligent software agent application programmed to acquire specific information) (2132), commonly referred to as "Shop Bots," and refer the order to an outside

vendor (2136). The system collects a commission from the vendor if the process results in a successful sale.

The results are first formatted for natural readability and easy comprehension, and then presented to the user (2090). The system provides the user options to sort the results in other ways, e.g., by price, quality, features, vendor, or alphabetically.

If the user makes a selection from the proffered matches, the system provides information and analysis (2100-2270) on items and vendors.

Rather than describing a desired item or items, at (2060) the user may choose to select an item from a list (2110) of all the products, services and bundles the system offers. The selection choices are presented in a typologically indexed format for ease of use. When user selects from the products and services arranged in Typology categories 1 -- 11 (2120) (described below and shown in Figs. 11a -- 11f), the system is triggered to provide the user with third-party information (2245 and 2247).

Referring next to Fig. 10b, after reviewing the third party ratings and customer opinions about vendors, the user selects a product or service item (2140). The system then provides detailed information (2150) about the selected item. The system uses intelligent agent software programs to facilitate data analysis and data synthesis functions. The system imports data from outside sources into the primary system memory. Information is analyzed according to specific item categories, e.g., quality, price, and item features. The system then assesses patterns in the data. Metric analysis of the data is used to create profiles of customers. For example, demographic data can establish an accurate profile of a customer. The system can identify trends in the data. By aggregating pools of customers, the system builds an accurate profile of each customer. The system is programmed to filter data according to specific item and profile categories.

The system creates buying recommendations for specific customers based on patterns assessed in the system database. Promotions are targeted to customers based on customer profiles. The system can predict and anticipate customer activity, such as buying habits, based on system data analysis and synthesis. Criteria based on data analysis is then used for updating customer profiles. Figure 19(b) shows an example of customer criteria, vendor criteria, as well as item criteria used for data analysis. Collaborative filtering as described above is one method of data analysis and synthesis. Editorial retailing and rating systems provide additional analytical methods with which to provide recommendations.

At this point, the system queries (2160) whether the user wants to receive information and analysis on an item. To make a further inquiry, the user is returned to the service inquiry process at (2060). If the user instead requests information comparing the chosen item to other similar products, the system provides comparison information (2170). Different types of comparison information are available for one item compared to other similar items within an area of the customer's interest. Comparisons for competing items can be based on price, features of service plans, product features, and quality. In the preferred embodiment illustrated in Fig. 19a, the user may request information by selecting one of the service and equipment vendors shown in the "Select One" drop-down menu. Similarly, comparison shopping information can be obtained by selecting the product category from the drop-down menu. In the illustration shown, "wireless" has been selected. A comparison spreadsheet will be provided regarding wireless services, depending on the user's selection of price, service features, quality, or other features elected by the user. Referring back to Fig. 10b, comparison information is determined by selection of pricing information on specific features (2180) of products and/or plans (2220) for services. Pricing is constantly refreshed by shop bots performing background searches (2190) on the web.

The system presents final pricing information (2200), by accessing vendor(s) databases (2230) over an Extensible Markup Language (XML)-enhanced link. XML is employed to facilitate communication with these vendor systems. Standardized XML dictionaries for specific industry types are used in the communication process. Vendors registered with the Universal Description, Discovery and Integration (UDDI) business registry are favored.

The system prompts the user to select an item and vendor at 2210. If the customer does not want to select any of the present options, the system returns to the new item query process at 2160. If the customer does select an item and vendor, then the system jumps to the Transaction Processing module at 8000 (Figs. 17a, et. al.).

If the user requests recommendations from the system (2160), the system requests further information (2240) from the customer that is necessary, in accordance with the Non-Intrusion Policy, to complete the customer's on-line profile. This information is then used to make recommendations. Fig. 19a shows a hyperlink for obtaining "Expert Recommendation" information. Recommendations are provided in many formats illustrated in Fig. 19b. For example, a user may instruct the system to provide comparisons of wireless

services commonly purchased by individuals between the ages of 30 to 39 in an established price range.

The customer may opt to obtain editorial retailing-type information in the form of vendor opinions and ratings from prior customer experiences (2245) or look at third party articles, such as time-sensitive publications by independent consumer testing and rating agencies, and reviews of vendors and items (2247). Alternatively, the customer may provide information about the customer's needs or circumstances to allow the system to enter its knowledge database (2250). Reference to Fig. 19c shows an example of threshold profiles for wireless telecom service providers. Fig. 19d illustrates a rate comparison chart for wireless telephone rates offered by Pacific Bell, depending on the duration of a contract for wireless services and the minimum monthly usage of minutes. Fig. 19e illustrates a comparison of wireless vendors according to editorial reviews. Figure 19f illustrates a sample page where the user may elect between prosumer reports, telecom reports, business reports, and equipment reports; sample telecom reports being illustrated in the figure. Figure 19g illustrates a posting of several vendor reviews of Pacific Bell on a one- to four-star rating system. Finally, Figure 20b illustrates a comparison chart for wireless services, illustrating features and price options for each of several vendors.

Using intelligent software agents, the system searches the knowledge base (2250) to match the user's request with system-accessible products and services. Collaborative filtering techniques are also used at 2260 as an engine to compile recommendations. The techniques used include (a) profile-based, (b) quality-based, (c) quantity-based, (d) price-based, (e) popularity-based, and/or (f) region-based needs-driven filtering. The basic technique employed is to accumulate information about customers and customers' purchasing habits. Information regarding customers is essentially demographic information, including the customer's interests, educational background, location, occupation, age, gender, and income bracket. Fig. 19b illustrates the scope of factors involved in the collaborative filtering process. Information regarding the customer's purchasing habits is accumulated as purchases are made on the system. The information increases with the number of purchases made by the customer. In one embodiment, data is obtained from third-party information sources related to a purchaser's consumer profile, expanding the system's fund of knowledge and hence the system's ability to make accurate and useful purchasing predictions. Information from each purchase is broken down, or filtered, by the item purchased, its features, price, quality,

popularity with prior users, and the quantity of the item purchased. The demographic and purchasing information is analyzed to determine if the customer's purchasing patterns and demographics are related to the purchasing patterns and demographics of other customers using the site. If a match or close similarity is found, the pattern is used to produce procurement suggestions for the customer, derived from similar products purchased by the other customers, but not yet purchased by the present customer. Once the system has compiled items responsive to the user's request, the system then presents information on these items to the user (2270) in a spreadsheet format.

The users select whether they want simple pricing or complex pricing (2280). For simple pricing, the system returns them to the comparative information process at (2170). For complex pricing, which enables the customer to negotiate with vendors, the system proceeds to the Procurement System module (3000).

Typology 1 - 11: Products/Services/Bundles

The typology of products, services and bundles is organized as follows:

1. Yield management services
2. Risk management services
3. Business services
4. Preset bundles
5. Customized products
6. Industrial parts and sub-assemblies
7. Made-to-order products
8. Customized services
9. Miscellaneous and used products
10. Small business services
11. Personnel and management resources

1. Yield Management Services consist of the following:

- a. Telecom services, including local telephone service (e.g., call forwarding, call waiting, caller ID, and other features); long distance; cable, intra lata, wireless, broadband Internet (e.g., satellite, DSL, T1/T3), and Internet connectivity services (ISP).
- b. Travel (e.g., airlines, car rentals, hotels, tours, and cruises)

- c. Utilities (e.g., electricity or other)
 - d. Rate plans, including Local (e.g., flat fee, fee for features, or no minimum for metered use), long distance (e.g., metered use, high peak and low peak, average over high peak and low peak, and minimum minutes within single organization, also known as bundles), wireless (e.g. flat fee, metered use, high peak and low peak, average over high and low peak, and bundles), and ISP (e.g., flat fee, and low off-peak with minimum use).
- 5
2. Risk Management Services consist of the following:
- 10 a. Finance, including loans, equipment leases, home loans, car loans, and credit cards.
 - b. Securities, including stocks, bonds, futures, and mutual funds.
 - c. Insurance, including Homeowners/tenants, auto, life, health, liability, and others.
- 15
3. Business Services consist of the following:
- a. Technology Consulting, including communication, web, e-commerce, computing, and third-party.
 - b. Corporate, including sales, customer service, advertising, human resources, marketing, and strategy consulting.
 - 20 c. Professional, including health, corporate/legal, and accounting.
4. Preset Bundles include the following:
- 25 a. Telecom Application Services, such as integrated telephony (e.g., equipment, software and services, voice and data synthesis (VoIP), and integrated messaging), teleconferencing (e.g., equipment, software and services for audio and data, video and mobile teleconferencing), data services (e.g., storage area networks (SANs), peer-to-peer messaging, and fax services), and wireless data (e.g., equipment, software and services, PDAs, mobile computers, wireless phones - data and/or voice, specific services, and software for numerous specific applications).
 - 30 b. Basic Telecommunications Services, such as local, long distance, wireless, and broadband Internet.

- 5 c. Financial Services, for car (e.g., loans, insurance, and related credit card items), home (e.g. home loan, equity loan, home insurance, mortgage insurance, revolving loan or credit card accounts, money market accounts or certificates of deposit, mutual funds, health insurance, and life insurance), or business (e.g., selected bundles, secured loans, equipment loans, credit cards, fire/theft insurance, liability insurance, money market accounts or certificates of deposit, mutual funds, health insurance, and life insurance).
- d. Other financial service bundles.
- 10 5. Customized Products consist of the following:
- a. Computers, including hardware (e.g., PCs and mobile computers), software, and peripherals
- b. Computer software, including application service provider (ASP), operating systems, browsers, search engines, databases, word processing, and spreadsheets.
- 15 c. Telecom Equipment, including video teleconferencing equipment, fax machines, telecom accessories (e.g., headsets, phone systems, menu systems, and handsfree devices), modems, pagers, phones (e.g., phone systems, 1-, 2-, and 3-line phones, and wireless phones), routers, networking equipment, PDAs, and appropriate software.
- 20 d. Office Products, including copiers, furniture, fax machines, and computer printers.
- e. High-end Equipment, including audio equipment and video equipment.
- f. Automobiles and trucks (new and used)
- 25 6. Industrial Parts & Sub-Assemblies consist equipment in the categories of oil and gas, plastics, rubber, steel, aerospace and aeronautical, automotive, computers, semiconductors, and telecom equipment.
7. Made-to-Order Customized Products consist of computers, automobiles, industrial machines, copiers, high-end electronics (audio/video), security systems, aerospace and aeronautical, custom furniture, semiconductors, and computer and telecom networks.
- 30

8. Customized Services consist of technology consulting projects, service contracts, marketing and advertising projects, professional services projects, and strategy consulting projects.
- 5 9. Miscellaneous and used products consist of computers, office equipment, audio and video equipment, antiques, carpets, photography equipment, autos and trucks, industrial equipment, CDs and DVDs, collectibles, watches and jewelry, art objects, software or books on demand, movies on demand, music on demand, or videos on demand..
- 10 10. Small business services consist of plumbing, electrical, gardening, household repair, technology advice and repair (e.g., computers, communications), and desktop publishing.
- 15 11. Personnel and management resources consist of general management (e.g., senior executives, administrators and middle management), health and medicine (e.g., medical doctors, nurses), information technology, science and engineering (e.g., scientists and technologists), manufacturing, professionals (e.g., lawyers, strategy management consultants, accountants, technology consultants), sales and marketing (e.g., sales, marketing, advertising and public relations, customer service), human resources (e.g., human resource management, benefits, compensation, and training), finance (e.g., CFOs, commercial banking, and investment banking), and materials management (e.g., inventory and quality control).
- 20

3. Interactive Procurement System (3000)

Customers enter the Interactive Procurement System module (3000) after having selected a product or service to purchase. At 3010 (Fig. 12) the system determines the kind of order processing to use according to the type of product/service/bundle that has been chosen.

25

Individual basic items, which include products, services, or preset bundles selected from typology categories 1-6, are routed to sales processing Module A (4000). Multiple item combination packages selected from typology categories 1-6 are directed toward sales processing Module B (5000). Made-to-order customized products and services selected from topology categories 7 and 8 are processed through sales processing Module C (6000). And

30

items selected from typology categories 1, 5, 9, 10, and 11 are processed through Peer-to-Peer Exchange Module D (7000).

In Modules A, B, C, and D, a customer accountability rating system makes a customer accountability rating available for sellers who have received a request. The seller may use the rating to make decisions regarding the prospective relationship with the customer. For example, the seller may decline to provide a bid if the customer accountability rating is unfavorable. Alternatively, the seller may provide a bid on better terms if the customer rating is favorable. The accountability rating system tracks the number of experiences the customer has had with the system, the number of those experiences that resulted in successful transactions, and vendor feedback. Each customer is then given a numerical rating representing the level of risk presented by the customer to the seller based on the customer's accountability rating. The customer's rating is updated with each new experience with the system. Customers are thus encouraged to employ fair bargaining tactics which complete a negotiation without unduly taking advantage of a seller. In Module D, a similar system rates sellers as well as buyers.

Negotiations need not be based on price alone. Seller or buyer may base their counteroffers on features rather than price in order to meet the demands of the buyer. Since items are originally identified based on a combination of features, feature-based counteroffers are actually more broad and inclusive than counteroffers based on price.

In the case of item quality differences, it is possible for a seller or buyer to make counteroffers based on quality rather than price. The seller can offer better or lesser items as a counter to a set price offer. A buyer can request better or lesser items as a counter to a specific price request.

In the case of geographic region of origin in which it may be an advantage to be of closer proximity, a buyer or seller may counter on regional proximity as a counteroffer to a set price.

In the case of item delivery time, it is possible for a buyer or seller to provide a counteroffer based on a faster or slower delivery time as a counter to a set price.

In the case of a combination of items, a buyer or seller may seek discounts based on multiple item bundles, including product and service combinations. Some products can be heavily discounted or even free if a substantial service commitment is made.

In the case of customer service, a buyer or seller may be flexible with price based on a difference in the quality of customer service, with a novice seeking increased quality customer service.

5 In the case of reputation of buyer and seller, a better reputation suggests a better discount or better features or quality than a poorer reputation.

Price can be flexible according to the quality, features, or region of origin of an item, or characteristics such as delivery time, customer service quality, buyer or seller reputation, and item combination bundles, taken alone or in various combinations. The price may be traded off with (a) varied item quality and item features, (b) item quality and quality of
10 customer service, (c) item quality and item delivery time, (d) item features and item delivery time, (e) item features and customer service quality, (f) bundles of items and customer service quality, (g) bundles of items and item quality, (h) bundles of items and item features, (i)
bundles of items and item quality and item features, (j) item quality and item delivery time, (k) item features and item delivery time, (l) item features, item quality and item delivery time, (m)
15 item features, item quality, item delivery time and quality of customer service, (n) reputation of buyer or seller and bundles of items, (o) reputation of buyer or seller and customer service quality, (p) reputation of buyer or seller and product features, (q) reputation of buyer or seller and item delivery time, (r) reputation of buyer or seller and item quality and item features, (s)
reputation of buyer or seller and item quality, customer service quality, item delivery time and
20 bundles of items and (t) other combinations of factors.

These multivariate item attributes allow customers to isolate the combinations of aspects that meet their preferences. Customer-based item negotiation based on multiple aspects offers far greater flexibility, and it also provides the seller an opportunity to track various item aspects to maximize sales.

25 Price elasticity can be established in the marketplace based on dynamic or nonlinear pricing as it is applied to services (capacity or revenue management and risk management) and products (cutting edge technology compared to trailing edge technology).

In the case of capacity management service categories (e.g., telecom, e.g., wireless and long distance services, and travel services, e.g., airline tickets and hotel reservations), high
30 peak services are typically more expensive while off-peak services are less expensive. Consequently, premiums are charged for high peak services, and discounts are offered for off-

peak services. However, discounts may be made available for high-peak users, while bundling off-peak services may occur with sufficient high-peak service commitment.

In the case of risk management (e.g., banking credit risk, insurance risk and securities investment risk), lower risks generally provide lower investment returns, better interest rates and better insurance risks for optimal premiums, while higher risks generally provide the opposite.

In the case of products, particularly technology products, "cutting edge" technology typically commands a price premium compared to older "trailing edge" technology. Similarly, a surplus of products can be discounted.

These pricing differences for different types of services and products affords buyers and sellers increased flexibility to match buyers with their preferences. By providing differentiated products and services, and by meeting buyer preferences, sellers can develop longer-term relationships than with specific item purchases alone.

By providing such flexibility, the present system maximizes both customer demands and seller sales, and promotes strategic relationships between buyers and sellers.

A request may also ask that responsive bids include an option. Similarly, sellers may submit bids having options.

3A. Procurement -- Basic Items & Preset Bundles (4000)

Procurement module A processes the purchase of specific items and preset bundles available for selection in Typology categories 1-6. For Specific Service items (4050) from Typology categories 1, 2, or 3, the user is prompted to select specific service features (4060). For Specific Equipment items (4070) from Typology categories 5 or 6, the user is presented the option of selecting specific equipment features (4080). For Application Bundles (4090) from Typology categories 4a or 4c, the user is prompted to select specific application service features (4100). For Service Bundles (4110) from Typology categories 1, 2, 3, or 4b, the user is prompted to select specific service bundles features (4120). If a user were to select wireless services, for example, a window such as illustrated in Figure 20a would appear, showing a list of wireless service vendors, some basic features of the services provided, and prices.

Thereafter, the customer proceeds to the negotiation phase of the purchase process, tagged as point 3X in the drawings. Customers are also routed here from other points in the system (e.g., 2130 and 4295).

Initially, the user is presented with an appropriate list of vendors capable of providing the selected service, product, or bundle. The user is prompted to choose at least four vendors (4130) from the list. Figure 20c illustrates a window showing a selection of core service vendors from the list presented in Figure 20b. The feature and price information is retained.

5 The narrowing of vendor choices forces the customer into a more focused purchasing mode reflecting "intelligent shopping" techniques carried out intuitively by customers daily.

Referring back to Figure 13a, the system assembles a bid request from selected vendors (4140), preferably using Extensible Markup Language (XML) to facilitate transfer and presentation of data in a format understandable to the customer. Other vertical market

10 electronic interface protocols may also be used in manners well known to those skilled in the art to communicate with vendors' systems. Protocol requirements are recorded in a vendor profile database for future interactions. In the preferred embodiment, system communication favors vendors registered under the Universal Description, Discovery and Integration (UDDI) business database (4150) by first searching for UDDI database-registered vendors capable of

15 fulfilling the customer's request. Thereafter, the system sends bid requests (4160) to all vendors identified either directly or to a system copy of the vendor's product database. If a request is forwarded directly to a vendor, the system establishes a real-time connection to the vendor's database via the Internet or a dedicated virtual private network (VPN). The vendor's bid then is received (4170), using an interface protocol (4165) consistent with that vendor's

20 product database. If the request is referred "internally" to the system's copy of a vendor's database, software agents interact with the internal vendor database to obtain a bid according to formulated guidelines agreed to and authorized by the vendor. Each request for an item is made either in terms of features desired by the customer in a product or service or by a selection of a specific product or service from the selected typology categories. The network

25 interface provides suggested features for each item listed in the typology categories; an option is also available for the customer to input other features not shown on the suggested list. The features that the customer indicates as being desired in the item are then compared against vendor-defined features maintained in each vendor's data base or in the systems copy of the vendor data base for responsiveness. If a favorable comparison is determined, indicating that

30 the vendor-defined features are responsive to the item as described by the customer's defined features, a bid is formulated from that vendor.

In an alternative embodiment, where the vendor-defined features are maintained in a vendor's memory or database in the vendor's computer, the vendor may issue an authorization to the system if it is determined that the vendor-defined features are responsive to the customer-defined features. Thereafter, the system formulates the bid, according to pre-agreed guidelines. This embodiment facilitates vendor updates of the features of each of the vendor's products, yet preserves automated submission of a bid in response to a customer request.

Different request and bidding embodiments are made available to the user and to vendors due to the flexibility of the procurement system. In one embodiment, a bid comprises an option contract wherein a vendor offers to sell the item selected to the purchaser at a specified price, but only after expiration of a time period. During the time period, the vendor retains the right to sell the selected item to a third party at a higher price. If the item is sold to the third party, the vendor commits to pay the original purchaser a penalty sum. The vendor will obviously not sell the item to the third party unless at a price higher than the price committed to the original purchaser plus the penalty sum.

Alternatively, the bid can include an "evaporating" offer comprising an inducement to the purchaser to commit to the bid. The inducement diminishes over a stated period of time, thus encouraging the purchaser to accept the bid early in the period. In the primary embodiment, the inducement is an amount which is calculated at the time of the acceptance, which may be stated initially at an attractive amount, but which diminishes over time, e.g., from day to day. Alternatively, the inducement could be the penalty sum, the promised amount of the payment diminishing during the stated period. In another alternative the option or inducement, rather than being price, may be stated in terms of a wide variety of terms, e.g., delivery time, a free printer for accepting the bid now, or a "virtual" store credit on the next transaction. Similarly, customers buying services under the risk management category may include futures as a term in their requests. In all cases, the option obligates the seller and provides a "pull" to encourage seller participation in the system, whereas the inducement of the evaporating offer provides a "push" to encourage the buyer to accept the proffered bid.

The system formats received bid data in a spreadsheet comparison chart (4180) for easy perusal by the user. The customer reviews the bids and then either narrows the vendor selection to at least two (4190) for further negotiations, or rejects all the bids and returns to (4130) for a new set of bids from at least four other vendors. Figure 20d shows a window

wherein the user has narrowed the selection of wireless service vendors to two. If the user wishes to accept one of the two service vendors' bids, the "Accept" button is selected.

In one embodiment of the method and system, all negotiations between a customer and two or more vendors are transparent, in that the bidding between the purchaser and any one of the bidding vendors is open to each of the other vendors. For example, if a purchaser has requested a new two-line telephone and has received bids from Vendor A and Vendor B, any negotiations between the purchaser and Vendor A are open and accessible to Vendor B, thereby encouraging direct competition between vendors during the negotiation process. In an alternative embodiment, negotiations are not transparent, the negotiations between a purchaser and any one vendor being private.

If two vendors are selected for further negotiations, the user may present a counter bid to either vendor or both (4200) based on different product features, service combinations, or pricing plans. In the illustrated embodiment shown in Figure 20e, the user inputs price and feature information into the window under the "Counter" button, and then selects the "Counter" or "Submit" button to transmit the counter-offer. The user may also press the "Go Back" button to return to the previous step in the negotiation process. A "Save Chart" button is also available if the user wishes to save the window for a return to the negotiations at another time. The user may elect to present a new request to both vendors (4210), or narrow the selection to one vendor (4260) and request a new bid only from that vendor.

When the customer sends new requests to two vendors (4220), if only one vendor submits a new bid to the customer's new request (4250), the user may choose to go to 4260 to negotiate further with that vendor. If both vendors respond with a new bid (4230) responsive to the user's new request, the user may then select one vendor to negotiate with further and go to 4260. Or, the user may reject both vendors' new bids (4240), and elect (4295) to go back (tag 3y) to the spreadsheet of bids initially presented at (4180), or (tag 3x) go back and choose at least four new vendors (4130).

When the user has narrowed down the selection to one vendor at (4260), the user may provide a counter-bid (4270), which the system presents to the vendor (4280). In the embodiment illustrated in Figure 20f, the user has filled in the first window below the "Counter" button for submission of a counter-offer (rendering the "Counter-Offer" window opposite the second service vendor inactive). Once the information has been entered, the "Submit" button is selected to transmit the counter-offer. In Figure 20f, a counter by the

vendor to the user's counter-offer is represented. The vendor's counter can be accepted by pressing the "Accept" button, or a new counter by the user can be made by filling in the "Counter" window and pressing the "Submit" button. If the vendor submits a counter-counter-bid (4290), the system replays the bid-counter-bid loop at (4260). If the vendor declines the user's counter-bid, the user may elect to choose new vendors (4295). If the vendor accepts the user's counter-bid (4270), negotiations with other vendors cease, and the user is prompted to confirm the bid (4300) and proceed to the Transaction Processing module (7000). For example, as shown in Figure 20h, a window is presented indicating that the vendor has accepted the user's offer. The user still has the option of countering further by filling in the "Counter" window, or confirming the offer, thereby ratifying the negotiation process. If the user does not confirm (4310) the bid, then the bid is saved in the user's profile for retrieval (4320) when the user logs back into the system and requests that the saved queries be presented at 2040. Alternatively, the user may choose instead to modify (4310) the bid request and return to the Information module (2000). At any point the user accepts a vendor's bid, negotiations with other vendors immediately cease. If the user's offer or counter-offer has been accepted, a window such as illustrated in Figure 20i is displayed, providing the user with options to save the transaction by pressing the "Save Chart" button, or proceeding to the transaction processing module by pressing "Transaction Processing" or the "Checkout" button.

20 **3B. Procurement -- Custom Bundles (5000)**

The custom bundle procurement module enables the user to mix and match multiple items to create custom bundles of products and services that best serve the user's needs.

The system prompts the user to consolidate a package of services, equipment, and/or applications (5010) from items in Typology categories 1-6, and then choose at least two vendors (5015) from which to receive bids for the specified bundle. Although more vendors could be chosen, greater efficiencies are achievable if the vendor selection is limited to two. Requests and bids are flexible as in Module A in that they are multivariate, may include option contingencies, and may depend on customer accountability ratings.

The customer is next prompted to specify the amount of time to wait (5020) for responsive bidding on the bundle - immediate only, 1 day, 3 days or more. As discussed in more detail below, more time may mean less cost.

The system categorizes and pools all orders (5030) to create volume, in order to command better pricing from vendors and pass the savings on to the users.

Each aggregated pool of orders is checked by the system to ascertain whether a predetermined minimum quantity of orders (5040) has been reached. The system may be
5 programmed to pool up to a set maximum number of orders, e.g., 100, or 1000, for a certain item, before triggering a bid request to appropriate vendors. The system also tracks time thresholds specified by customers and triggers a bid request to appropriate vendors, whether or not the quantity threshold has been reached, when a specified time has passed.

The loop at 5050 to 5190 represents one of many parallel loops that run
10 simultaneously for each customer that has placed an order within this procurement process.

The system sends bid requests (5050) to specific chosen vendors in appropriate categories using XML, or other vertical market electronic interface protocol (5065) to format the bids as required to communicate with the vendors' systems. UDDI-registered vendors are preferred as in the basic items procurement module. The system records the protocol
15 requirement in each vendor's data record for future interactions.

The system receives bid proposals (5060) from vendors, using the same vertical market language interface used by the vendor. Intelligent software agents interact with vendor systems in an automatic mode, which may be manually overridden by each vendor.

The customer requests are then separated into their individual component parts -- one
20 component for each item of the custom bundles -- and sub-bids obtained for each item from the participating vendors. Once at least one sub-bid is received for each item, all the sub-bids are assembled (5070) to form one or more bids for the bundle from the two vendors. The pooling of requests and selection of optimum sub-bids with which to formulate a best bid, increases the likelihood of closing a transaction with the customer and allows a lowest-cost
25 bid to be formed from the sub-bid selection made available by the process.

The customer may reject all proffered bids (5080) and return to the top of the loop at (5015) to select at least two new vendors, or the customer may select parts or all of either bid (5090). The user can then accept the full or partial bids (5100) that they have selected and proceed to the Transaction Processing module (8000), or they may choose to interpose a
30 counter bid responsive to the vendors' bid or bids. The counter-bid to each vendor may include only counter-bids to the sub-bids made by that vendor or may include a comprehensive counter-bid for every component part of the bundle supplied by that vendor.

The system sends the counter bid (5110) to one or both vendors, which the vendor(s) may choose to reject, counter, or accept in full (5120).

If there are any accepted items, the system prompts the customer to confirm the vendor(s) partial acceptance of the counter-offer (5140). Confirmation terminates negotiations with other vendors for the item accepted. The customer's order is assembled (5150) based upon the bids accepted during the negotiation process, and the system prompts the customer to confirm the total order (5160).

Once the vendor receives the confirmation, the customer enters the Transaction Processing (8000) phase. If the customer chooses not to confirm the order, the customer can modify the order (5180) by returning to the top of Section 3B at (5010). If the customer does not choose to modify the order at present, then the order is saved (5200) for a later session when the user logs into the system and requests previous orders.

If the vendor(s) accept(s) the customer's counter offer at 5120, the system prompts the customer to negotiate (5170) any further items, or proceed to confirming the vendor(s) acceptance of the counter bid at (5140). If there are further items to negotiate, the customer may send another counter-offer to vendor(s) (5190). If the customer decides not to negotiate further, then the process proceeds to 5140, towards the closing of the transaction.

3C. Procurement – Made-to-Order Customized Products and Customized Services (6000)

This procurement module processes made-to-order products and customized services from Typology categories 7 or 8 that are tailored to customer specifications.

When a product can be designed, ordered, manufactured, and distributed on demand, it is customized to the needs of the customer. Customization may require having the customer provide information sufficiently specific for vendors to provide appropriate bids.

The system seeks as much detailed information as possible about the customer in order to best fulfill the customer's needs with the product or service described. At 6020, the system prompts the customer to enter detailed information about the customer and detailed specifications about the products or services sought. In one embodiment, the information on the customer includes detailed specifications about the customer's demographic profile, interests, systems, and similar purchases. At 6030 a list of vendors that fit the category is presented, and the customer is prompted to choose at least four vendors from this list. As in

the basic items procurement module, the narrowing of vendor choices forces the customer into a more focused, and therefore more productive, purchasing mode.

XML (6040), or other vertical market electronic interface protocols, are used to format the query as required to communicate with vendors' respective systems. At this point, the system converts the information about the customer into product or service features, depending upon the items stated in the customer's request. For example, if a customer formulates a request for a camera, and the system is aware that the user has a higher-than-average income, the system may increase the range of quality defined in the product features before transmitting the request to the vendors. As another example, if the customer has formulated a request for a winter coat, the system may input different thickness requirements depending on whether the customer lives in New England or the Los Angeles Basin. Protocol information is stored in each vendor's data record. UDDI-registered vendors are favored as above. Additionally, as in Modules A and B, requests and bids are flexible in that they are multivariate, may include option contingencies, and may depend on customer accountability ratings.

The system sends the custom bid request to each vendor (6050) via optimum communication protocols. When the bids are received, the system formats the data as a spreadsheet for clear presentation to the customer (6070). In the event several bid requests for similar items are received at about the same time, or if a single request is for two or more of the same item, the request may demand or the seller's bid may offer a reduced price per item. The system prompts the customer to focus the process for further negotiation to at least two vendors (6080), or reject all bids and return to 6030 to choose a new set of vendors.

The customer may then accept all or part of either offer (6090) from the two chosen vendors and proceed towards transaction processing (6220). Or, the customer may choose to counter (6100) based on features, price, quality, location, or ship date.

The system sends the customer's counter-bid to the at least two chosen vendors (6180) where it can be accepted, rejected (6190) or manually overridden by the vendor. Alternatively, the vendor(s) may make another counter-offer.

If the customer's counter offer is rejected, the system checks whether the item has been accepted (6120) in any customer's bid sessions in that category. If the vendors did not accept the customer counter bid on an item, then the customer is looped back to (6030) at the top of Section 3C. If there is an accepted item, the system prompts the customer to confirm

the vendor(s) acceptance of the counter offer (6130). As in other modules, confirmation terminates the negotiations with other vendors as to an accepted item. The customer's order is assembled (6140) based upon the bid accepted during the negotiation process. The system prompts the customer to confirm the order (6150).

5 Once the vendor receives the confirmation, the customer enters the Transaction Processing (6220) phase. If the customer chooses not to confirm the order, the customer can modify the order (6160) by returning to the top of Section 3C at (6030). If the customer does not choose to modify the order at present, then the order is saved (6170) for a later session when the user logs into the system and requests previous orders.

10 If a vendor accepts the customer's counter offer (6190), the system prompts the customer to negotiate (6200) any further items, or proceed to confirming the vendor's acceptance of the counter bid at (6120). If there are further item aspects to negotiate, the customer may send another counter offer to vendor(s) (6210). However, if there are further item aspects to negotiate, but the customer decides not to counter, then the process proceeds to (6160), towards the closing of the transaction.

15 At each stage of negotiations, when a counter-bid or new request is issued, the customer is informed that the system will send an e-mail when the vendor(s) counter offers are received. An active hyperlink tag in the e-mail will bring the customer directly to a web page where the negotiation process can continue.

20 When the customer confirms the order, the system requests further detailed information from the customer (6220) that is necessary to process the order, in accordance with the Non-Intrusion policy. The system informs the customer about prepaid deposit requirements and other terms for custom orders (6230), and then proceeds to the Transaction Processing module (8000).

25 **3D. – Peer-to-Peer Exchange (7100)**

The peer-to-peer exchange module processes orders which are purchased and sold more on a single-instance basis, rather than in volume. Peer-to-peer caters to non-commercial transactions, but it is understood that it could be applied for the sale or acquisition of an item in a commercial setting.

30 Referring to Figure 16(a), the system obtains identifying information from a prospective seller (7010) and the seller enters into a system memory detailed information regarding the product or products for sale or regarding the service for hire (7020). A

categorization scheme is suggested to the seller, or the seller may select a category, in which to place the identifying information (7030-7040). The system then places the identifying information in the proper category (7050) and indexes the item according to appropriate item attributes.

5 As seen in Figure 16(b), the buyer initially proceeds to selection of a product or service item (7100). The buyer can elect to select an item by description of features, or by selecting an item from a hierarchical typology. If the former, the buyer provides a list of features desired in the item (7110). As in other modules of the system, menus are presented to the customer depending on the product or service area that the customer indicates is of
10 interest. Different suggested features for cameras would, for example, be presented than for automobile parts or wireless telecommunications services. The features are processed by the system and generate a search of the system database for items available for sale. A list of these sellers is generated (7130).

 If the buyer desires to select an item from the typology, items from categories 1, 5, 9,
15 10, and 11 are presented, according to the hierarchical typology discussed above, items in these categories being amenable to the peer-to-peer exchange module. In response to a selection of an item, the system generates a list of sellers of items providing a match (7130).

 In an alternate embodiment, the buyer may elect to grant access by other buyers of the same or similar items to that buyer's negotiations with vendors. In exchange for granting such
20 access, the buyer obtains access to the negotiations of all other buyers who have granted access to their negotiations. In this manner, each buyer obtains information regarding the progress and outcomes of buyers with similar goals, thereby facilitating and improving the buyer's bargaining process.

 The buyer may narrow the list of sellers by entering additional features of the item
25 after having had a chance to examine the list of sellers and items for sale. For example, the buyer may wish to exclude all items below a certain cost to concentrate on higher quality. Here again, as in Modules A - C, requests and bids are flexible in that they are multivariate, may include option contingencies, and may depend on customer accountability ratings. Once a refined set of features and/or terms is specified, a new list of sellers is generated (7150).
30 The buyer then examines the prices shown (7160) and elects to respond with a counterbid, or not (7210). See Figure 16c. If the buyer elects not to provide a counterbid, the buyer may still decide to narrow the list further (7260), e.g., by further refining features, in which case

the buyer is looped back to the counterbid option at (7210). Alternately, the buyer may cease negotiations (7270). If there are any items as to which agreement has been reached (7280), the buyer may proceed to confirm them (7290) and go on to transaction processing for completing the purchase. If an item is selected, negotiations with other vendors automatically
5 cease. If there are no items as to which agreement has been reached at 7280, the buyer optionally may return to the beginning of the peer-to-peer module to start the process anew.

If at 7210 the buyer elects to provide a counteroffer, that offer is sent to at least one seller (7220). The offer may be provided and processed in real time, or in a chronologically stepped process via, e.g., e-mail. Inherent in the system, as with the other procurement
10 modules discussed above, is the ability of the consumer to bookmark or freeze the transaction, so that it may be returned to, within constraints, at a later time to continue the process.

In response to the buyer's counteroffer, the buyer may receive bids from one or more sellers (7230), whereupon the buyer may accept one of the seller's bids, reject all bids, or send out a new request to two or more sellers (7240). If the buyer accepts a bid, the buyer is
15 passed to 7270 for further negotiation, if desired, and closing. If all bids are rejected, the buyer may return to 7100 to begin the process again. Finally, if the buyer formulates a new request, sellers may provide counteroffers (7250) which the buyer may accept or reject (7210), or the sellers may reject the buyer's new request.

4. Transaction and Post-Sale Processing (8000)

20 The customer arrives at this module after confirming an order. Fig. 21 shows an introductory window to the Transaction Module.

The system offers the customer a service contract (8010) on any equipment that the customer ordered.

The system determines whether the billing (8020) is to be done by the vendor or by the
25 system. For vendor billing, the system passes the order to the vendor (8030), and collects a commission (8040).

If the billing is to be done by the system, the system checks (8050) whether this is a previous customer, whose billing information is already on file. If so, then the system proceeds to 8225 to finish processing the transaction.

30 For a new customer (8050) whose billing information is not on file, as seen in Fig. 21, the system prompts the customer to provide the necessary (8060) information, according to

the Non-Intrusion policy. The system then verifies the identity of the customer (8070) through various on-line sources and creates a record for the customer.

5 If the total order costs more than \$500, the system performs a credit check (8080) through an on-line credit bureau, and then prompts the customer to select a method of payment (8090).

Security encryption is employed to process the payment.

If the user elects to use a credit card (8100), the system requests the credit card information (8110), processes the credit card, and receives an authorization code from the creditor (8210).

10 If the user requests the charges to be added to their phone bill (8120), the system proceeds to obtain authorization from the customer (8130).

If the user wishes to make payment by electronic funds transfer (8140), the system prompts the customer to enter the routing and inter-bank information (8150).

15 If the user wishes to pay by check or money order (8160), the system prompts the customer to enter the required information to process the payment (8170) based upon the check acceptance policy.

If the user requests an extension of credit in order to complete the transaction (8180), the system requires the user to fill out a credit application (8200), and sends the customer's information to the credit provider (8220). Once credit is approved (8280), the system
20 proceeds to payment confirmation (8290). If credit is not approved, then the order is put into pending status (8320) and the credit refusal information is e-mailed to the user with the order information. The query is saved for later retrieval (8330) when the user logs back into the system and requests to review pending orders (2040).

25 For previous customers (8050), the system calculates the sales tax (8225), and proceeds to process the transaction (8230). The customer is prompted to select a payment method (8240).

Security encryption is provided for all sensitive communication between user and system.

30 Users may elect to use the same payment method (8250) that they used for a previous transaction, or they may choose to charge the purchase to their system account (8260), or they may choose a different payment method (8270) from the options offered in 8090 to 8280.

Once payment is confirmed (8290), the system creates a final invoice (8300) that reflects the savings relative to the manufacturer's suggested retail price (MSRP). If payment is not confirmed, the order is assigned a pending status (8320) that is e-mailed to the user, and the order is saved for later access (8330).

5 As part of the final processing, the system presents philanthropic options (8310). Customers may donate up to 1% of their sales proceeds (up to \$50 per transaction) to a charity of their choice. The system processes the request.

 The system creates a contract (8340) for the purchase and prompts for the user's digital signature (8350). Order(s) are placed with the vendor(s) (8360) and payment is made
10 to the vendor (8270). The completed transaction is registered into the system's database (8380) as well as the user's profile record. The query is saved (8400) in case the user wants to repeat the order at some later time. The query may be retrieved at 2040 (Fig. 9a).

 After the order is sent to the vendor, the system tracks the order fulfillment process (8410), by contacting both the user and vendor via e-mail or through the customer service
15 department, until the customer receives the product(s) and/or the service(s) have been activated (8240).

 Recurring orders are added to the user's calendar and profile (8510), and the customer is reminded to reorder at the scheduled time.

 Once the order has been filled, the system requests post-sale information in the form of
20 the customer's opinions about the vendor (8530) in an effort to track customer satisfaction (8540). If customer satisfaction is low, the system notifies the customer service department to correct the problems. The more the customer uses the system, the more the system learns about the customer's preferences to build a more accurate profile.

 The system updates the user profile (8550) with the post-sale information.

25 At the end of the cycle, the presentation manager presents item-driven collaborative filtered choices to the customer (8550), suggests new services (8560) and/or presents targeted advertisements (8570).

 The system attempts to mimic the intuitive method of shopping commonly used by
30 persons in non-online situations. For example, if a customer were interested in acquiring cell phone services, the first step would be to learn which vendors provide the desired service. Then the customer would likely determine what features are offered by the various vendors and narrow the vendor selection to a set of "finalists." The finalists would then be compared

with greater scrutiny and the selection narrowed to one or two. The customer might then communicate directly with the remaining vendors to determine if a better deal could be negotiated before actually consummating a transaction. The applicant's system allows buyers to develop a systematic relationship with the system as an intermediary, facilitating "customer-
5 centric" purchasing. The system also allows sellers to have a neutral competitive playing field for selling their products and services.

There have thus been described and illustrated certain preferred embodiments of an improved shopping system according to the invention. Although the present invention has been described and illustrated in detail, it is clearly understood that the same is by way of
10 illustration and example only and is not to be taken by way of limitation, the spirit and scope of the present invention being limited only by the terms of the appended claims and their legal equivalents.

I claim:

- 2 1. A method for procurement using a computer that communicates over a network, the
3 method comprising:
4 receiving from a purchaser a request to receive bids to sell a selected item specified
5 from a collection of products and services,
6 obtaining a bid to sell said selected item from at least one of a plurality of vendors, and
7 sending said bid to said purchaser.
- 1 2. A system for procurement that communicates over a network, the system comprising:
2 a memory for maintaining a list of individual product items and individual service
3 items;
4 one or more network interfaces adapted to send and receive data to and from
5 customer nodes and vendor nodes; and
6 one or more processors in communication with the memory,
7 wherein, when the one or more network interfaces receive a request from a customer
8 node to receive bids to sell a selected item specified from the list, the one or more processors
9 submit the request to one or more selected vendor nodes, and
10 wherein, when the one or more network interfaces receive a bid from a vendor node,
11 the one or more processors submit that bid to the customer node.
- 1 3. A computer program product comprising a machine readable medium on which is
2 provided program instructions for performing a method for procurement using a
3 computer that communicates over a network, the program instructions comprising:
4 program code for receiving from a purchaser a request to receive bids to sell a selected
5 item specified from a collection of products and services,
6 program code for obtaining a bid to sell said targeted selection from at least one of a
7 plurality of vendors, and
8 program code for sending said bid to said purchaser.
- 1 4. The method of claim 1 including:
2 receiving an acceptance to said bid from said purchaser.

- 1 5. The method of claim 1 including:
2 receiving said request from one of a plurality of networks, said plurality of networks
3 including a wide area network of computers, a cable television network, and wireless
4 telephone network.
- 1 6. The method of claim 1 including:
2 receiving said request from a wide area network of computers.
- 1 7. The method of claim 1 including:
2 receiving said request from a cable or satellite television network.
- 1 8. The method of claim 1 including:
2 receiving said request from a wireless telephone network.
- 1 9. The method of claim 1 wherein:
2 said request includes a set of customer-defined attributes particular to said selected
3 item.
- 1 10. The method of claim 9 including:
2 providing detailed information to said purchaser pertinent to said selected item.
- 1 11. The method of claim 10 including:
2 obtaining said detailed information from a third party information vendor.
- 1 12. The method of claim 10 including:
2 providing said detailed information for said purchaser to identify a set of customer-
defined attributes particular to said selected item.
- 1 13. The method of claim 9 including:
2 processing an interactive bidding negotiation between said vendor and said purchaser
3 in response to submission of said bid.

- 1 14. The method of claim 9 including:
2 providing procurement suggestions to said purchaser.
- 1 15. The method of claim 14 including:
2 accumulating data regarding said purchaser's purchasing history to form a consumer
3 profile for said purchaser,
4 said procurement suggestions include predictions of product or service items said
5 purchaser may wish to procure based on said purchasing history.
- 1 16. The method of claim 15 wherein:
2 said data comprises data obtained from third parties regarding purchasing patterns
3 similar to said purchaser's purchasing history.
- 1 17. The method of claim 9 wherein:
2 said customer-defined attributes include product features of said selected item.
- 1 18. The method of claim 9 including:
2 processing a comparison of a plurality of sets of vendor-defined features against said
3 customer-defined attributes for responsiveness to said request, each said set of said vendor-
4 defined features maintained for one of said plurality of vendors in a vendor database of said
5 computer.
- 1 19. The method of claim 13 including:
2 sending said bid to sell said selected item to said purchaser if said vendor-defined
3 features are responsive to said customer-defined attributes.
- 1 20. The method of claim 18 including:
2 said vendor database comprising a plurality of sets of vendor-defined features, each
3 said set associated with one of said plurality of vendors, and
4 receiving at predetermined intervals from each of said plurality of vendors an updated
5 set of vendor-defined features for updating said associated set of vendor-defined features.

- 1 21. The method of claim 9 including:
2 sending said request to a plurality of vendors for comparison of a set of vendor-
3 defined features maintained by each of said vendors in a vendor database against said
4 customer-defined attributes for responsiveness to said request, and
5 receiving from said vendor an authorization to submit said bid if said vendor-defined
6 features are responsive to said customer-defined attributes.
- 1 22. The method of claim 21 including:
2 receiving said authorization unless said request is rejected by said vendor.
- 1 23. The method of claim 22 wherein:
2 one or more of said plurality of vendors is registered with the UDDI business registry.
- 1 24. The method of claim 1 wherein:
2 said bid comprises an option for said vendor to sell said selected item to another
3 purchaser for a price higher than stated in said bid.
- 1 25. The method of claim 24 including:
2 said option specifying a time period at the expiration of which the sale of said selected
3 item to said purchaser shall be consummated, that before said expiration seller may sell said
4 selected item to another purchaser for a price higher than stated in said bid, and that if said
5 selected item is sold to said another purchaser, said vendor shall pay a penalty sum to said
6 purchaser.
- 1 26. The method of claim 9 including:
2 providing to said purchaser an index of said collection of product and services items,
3 said index comprising (a) basic items including services, products and preset bundles, (b)
4 custom bundles of services, equipment and applications, (c) made-to-order customized
5 products, and (d) peer-to-peer items.
- 1 27. The method of claim 26 wherein:

1 said request specifies said selected item from said basic items, said basic items
2 comprising a service group consisting of yield management services, risk management
3 services, and business services, said yield management services comprising travel,
4 telecommunications and energy services, said risk management services comprising financial
5 and insurance services, and said business services comprising technology consulting,
6 corporate and professional services.

1 28. The method of claim 27 wherein:

2 said request specifies said selected item from said basic items, said basic items
3 comprising an equipment group consisting of customized products and industrial parts and
4 subassemblies, said customized products comprising computer, computer software,
5 telecommunications equipment, office product, and high-end consumer electronic equipment
6 product groups, and said industrial parts and subassemblies comprising oil and gas, plastics,
7 rubber, aerospace and aeronautical, automotive, computer, semiconductor and
8 telecommunications product groups.

1 29. The method of claim 27 wherein:

2 said request specifies said selected item from said basic items, said basic items
3 comprising an application bundles group consisting of telecommunications applications
4 services and financial services, said telecommunications applications services comprising
5 integrated telephony, teleconferencing, data, and wireless services, and said financial services
6 comprising automobile, home, business and general financial services.

1 30. The method of claim 27 wherein:

2 said request specifies said selected item from said basic items, said basic items
3 comprising a service bundles group consisting of yield management services, risk management
4 services, business services, and basic services, said yield management services comprising
5 travel, telecommunications and energy services, said risk management services comprising
6 financial and insurance services, said business services comprising technology consulting,
7 corporate and professional services, and said basic services comprising, local, long distance,
8 wireless and broadband Internet services.

1 31. The method of claim 27 including:
2 processing a reciprocal interactive bidding negotiation between said purchaser and said
3 vendor in response to submission of said bid.

1 32. The method of claim 31 including:
2 processing a reciprocal interactive bidding negotiation between said purchaser and a
3 plurality of vendors in response to a bid by each of said plurality of vendors, and
4 pausing said negotiations with all except one of said plurality of vendors while
5 continuing said negotiation with the remaining vendor.

1 33. The method of claim 31 including:
2 receiving from said purchaser an instruction to limit said request by selecting four or
3 more vendors from which to receive said bids.

1 34. The method of claim 33 including:
2 comparing each of a plurality of sets of vendor-defined features against said customer-
3 defined attributes for responsiveness to said request, each said set of vendor-defined features
4 maintained in a vendor database associated with one of said plurality of vendors.

1 35. The method of claim 34 including:
2 receiving a bid to sell said selected item from each of said vendors if said associated
3 set of vendor-defined features is responsive to said customer-defined attributes, and sending
4 said bid to said purchaser.

1 36. The method of claim 34 wherein:
2 said comparing is performed by Extensible Markup Language.

1 37. The method of claim 34 wherein:
2 at least one of said plurality of vendors is registered with the UDDI business registry.

1 38. The method of claim 33 including:

1 sending said request to each of said vendors for comparison of said vendor-defined
2 features against said customer-defined attributes for responsiveness to said request, said
3 vendor-defined features maintained in a vendor database by each said vendor.

1 39. The method of claim 38 including:
2 receiving an authorization to send a bid to sell said selected item from said vendor, and
3 sending said bid to said purchaser upon receipt thereof from said vendor.

1 40. The method of claim 33 including:
2 receiving from said purchaser at least one request to submit new bids to two or more
3 of said four or more vendors based on revised customer-defined attributes.

1 41. The method of claim 40 including:
2 sending said request for new bids to said two or more vendors.

1 42. The method of claim 41 including:
2 Receiving from each of said two vendors a new bid responsive to said request for new
3 bids.

1 43. The method of claim 41 including:
2 receiving from each of said two vendors a new bid responsive to said request for new
3 bids, said new bid accessible to said other vendor.

1 44. The method of claim 43 including:
2 receiving from said purchaser at least one counter-offer to said new bid.

1 45. The method of claim 44 including:
2 obtaining from at least one of said vendors a counter-counter-offer to said purchaser's
3 counter-offer, and
4 providing said counter-counter-offer to said purchaser.

1 46. The method of claim 45 wherein:

1 receiving from said purchaser an acceptance to said vendor's counter-counter-offer.

1 47. The method of claim 40 including:
2 obtaining at least one new bid responsive to said request to submit new bids, and
3 providing said new bid to said purchaser.

1 48. The method of claim 47 including:
2 receiving from said purchaser at least one counter-offer to said new bid.

1 49. The method of claim 48 wherein:
2 receiving an acceptance from one of said vendors to said counter-offer.

1 50. The method of claim 48 including:
2 receiving from at least one of said vendors a counter-counter-offer to said purchaser's
3 counter-offer.

1 51. The method of claim 50 including:
2 receiving an acceptance from said purchaser to said vendor's counter-counter-offer.

1 52. The method of claim 26 wherein:
2 said request specifies said selected item from said custom bundles.
3

4 53. The method of claim 52 wherein:
5 said bid comprises an option for said vendor to sell said selected item to another
6 purchaser for a price higher than stated in said bid.

1 54. The method of claim 53 including:
2 said option specifying a time period at the expiration of which the sale of said selected
3 item to said purchaser shall be consummated, that before said expiration seller may sell said
4 selected item to another purchaser for a price higher than stated in said bid, and that if said
5 selected item is sold to said another purchaser, said vendor shall pay a penalty sum to said
6 purchaser.

1 55. The method of claim 52 including:
2 said custom bundles comprising a plurality of packages of individual service items,
3 individual equipment items, and individual applications items, said items each selected from a
4 group consisting of yield management services, risk management services, business services,
5 telecommunications applications services, basic services, financial services, customized
6 products, and industrial parts and subassemblies, said yield management services comprising
7 travel, telecommunications and energy services, said risk management services comprising
8 financial and insurance services, and said business services comprising technology consulting,
9 corporate and professional services, said telecommunications applications services comprising
10 integrated telephony, teleconferencing, data, and wireless services, said basic services
11 comprising, local, long distance, wireless and broadband Internet services, said financial
12 services comprising automobile, home, business and general financial services, said
13 customized products comprising computer, computer software, telecommunications
14 equipment, office product, and high-end consumer electronic equipment product groups, and
15 said industrial parts and subassemblies comprising oil and gas, plastics, rubber, aerospace and
16 aeronautical, automotive, computer, semiconductor and telecommunications product groups.

1 56. The method of claim 52 including:
2 receiving from said purchaser an instruction to limit said request by selecting two or
3 more of said plurality of vendors from which to receive said bids.

1 57. The method of claim 56 including:
2 pooling a plurality of requests to purchase said selected item from a plurality of
3 purchasers.

1 58. The method of claim 57 including:
2 holding said pooled requests for a specified time before presenting said requests to
3 vendors for bidding.

1 59. The method of claim 57 including:

2 holding said pooled request until a specified threshold has been attained before
3 presenting said requests to vendors for bidding.

4 60. The method of claim 59 wherein:
5 said bid comprises an option for said vendor to sell said selected item to another
6 purchaser for a price higher than stated in said bid.

1 61. The method of claim 60 including:
2 said option specifying a time period at the expiration of which the sale of said selected
3 item to said purchaser shall be consummated, that before said expiration seller may sell said
4 selected item to another purchaser for a price higher than stated in said bid, and that if said
5 selected item is sold to said another purchaser, said vendor shall pay a penalty sum to said
6 purchaser.

1 62. The method of claim 61 wherein:
2 said bid includes an inducement for said purchaser to accept said bid, said inducement
3 diminishing over a stated period of time.

1 63. The method of claim 62 wherein:
2 said inducement is a sum, the amount of which is set at the time of acceptance.

1 64. The method of claim 58 including:
2 receiving from said purchaser a specified holding time.

1 65. The method of claim 64 including:
2 providing an enumerated list of specific times for selection by said plurality of
3 purchasers, and
4 receiving from each of said plurality of purchasers a selection from said specific times.

1 66. The method of claim 65 wherein:
2 said enumerated list consists of immediately, one day, three days, and period of more
3 than three days..

1 67. The method of claim 59 including:
2 providing to said purchaser a plurality of packages of individual service, equipment
3 and applications items, said items each selected from a group consisting of yield management
4 services, risk management services, business services, telecommunications applications
5 services, basic services, financial services, customized products and industrial parts and
6 subassemblies,
7 receiving from said purchaser a selection of said selected item from said plurality of
8 packages,
9 obtaining from said two vendors a plurality of sub-bids for each of said individual
10 items of said custom bundle, and
11 assembling from said plurality of sub-bids an assortment of sub-bids into at least one
12 bid to sell said custom bundle, said assortment consisting of one said sub-bid for each said
13 item of said custom bundle.

1 68. The method of claim 67 wherein:
2 each said sub-bid is associated with one of said two vendors,
3 said method further including receiving from said purchaser a rejection of at least one
4 of said sub-bids, and
5 receiving from said purchaser a counter-bid to said rejected sub-bid.

1 69. The method of claim 68 including:
2 said counter-bid including and based on a revised set of said customer-defined
3 attributes.

1 70. The method of claim 68 including:
2 receiving from said associated vendor an acceptance of said counter-bid.

1 71. The method of claim 68 including:
2 receiving from said associated vendor a counter-counter-bid responsive to said
3 purchaser's counter-bid, and
4 submitting said counter-counter-bid to said purchaser.

- 1 72. The method of claim 71 including:
2 receiving an acceptance to said counter-counter-bid from said purchaser.
- 1 73. The method of claim 26 including:
2 receiving said purchaser's selection of said selected item from said made-to-order
3 customized products.
- 1 74. The method of claim 73 wherein:
2 said made-to-order customized products comprises a plurality of component parts,
3 each component part selected from a group of individual made-to-order product items and
4 individual customized service items,
5 the method further including receiving from said purchaser an instruction to limit said
6 request by receiving said bids from a selection of four or more vendors,
7 obtaining from said selection of vendors at least one sub-bid for each of said
8 component parts of said selected item, and
9 combining said sub-bids into at least one bid to sell said selected item.
- 1 75. The method of claim 74 wherein:
2 said bid comprises an option for said vendor to sell said selected item to another
3 purchaser for a price higher than stated in said bid.
- 1 76. The method of claim 75 including:
2 said option specifying a time period at the expiration of which the sale of said selected
3 item to said purchaser shall be consummated, that before said expiration seller may sell said
4 selected item to another purchaser for a price higher than stated in said bid, and that if said
5 selected item is sold to said another purchaser, said vendor shall pay a penalty sum to said
6 purchaser.
- 1 77 The method of claim 76 wherein:
2 said bid includes an inducement for said purchaser to accept said bid, said inducement
3 diminishing over a stated period of time.

2 said vendor database comprises a plurality of sets of vendor-defined features, each said
3 set associated with one of a plurality of vendors, said plurality of vendors including said four
4 or more vendors,

5 the method further including receiving at predetermined intervals from each of said
6 selection of vendors an updated set of vendor-defined features for updating said associated set
7 of vendor-defined features.

1 84. The method of claim 74 including:

2 sending said request to each of said selection of vendors for comparison of said
3 vendor-defined features against said component characteristics for responsiveness to said
4 request, each said set of vendor-defined features maintained by said vendor in a vendor
5 database, and

6 obtaining from each said vendor an authorization to submit a sub-bid for each of said
7 component parts for which said vendor-defined features are responsive to said characteristics.

1 85. The method of claim 84 including:

2 issuing said authorization based on preagreed guidelines with said vendor.

1 86. The method of claim 85 including:

2 automatically issuing said authorization if said vendor does not reject said request.

1 87. The method of claim 80 wherein:

2 said comparing is performed by Extensible Markup Language.

1 88. The method of claim 80 wherein:

2 at least one of said vendors is registered with the UDDI business registry.

1 89. The method of claim 74 including:

2 receiving from said purchaser at least one new request to submit new bids to two or
3 more of said selection of vendors based on revised customer-defined attributes.

1 90. The method of claim 74 including:

2 processing a reciprocally active bidding negotiation between said purchaser and said
3 selection of vendors.

1 91. The method of claim 80 including:
2 receiving from said purchaser an instruction to limit said request by selecting two or
3 more vendors with which to further negotiate based on revised customer-defined attributes.

1 92. The method of claim 91 including:
2 receiving from said purchaser at least one new request to submit new bids to at least
3 one of said two or more vendors based on said revised customer-defined attributes.

1 93. The method of claim 91 including:
2 obtaining at least one new bid from said two or more vendors based on said revised
3 customer-defined attributes.

1 94. The method of claim 93 including:
2 receiving an acceptance from said purchaser to said new bid.

1 95. The method of claim 93 including:
2 receiving from said purchaser at least one counter-offer responsive to said new bid,
3 and sending said counter-offer to one of said two or more vendors.

1 96. The method of claim 95 including:
2 receiving from said vendor an acceptance to said counter-offer.

1 97. The method of claim 12 wherein:
2 receiving from said purchaser a set of features related to said selected item, and
3 searching a global computer network for products and services correlating to said
4 features.

1 98. The method of claim 97 including:
2 performing said searching using Shop Bots.

- 1 99. The method of claim 98 including:
2 selecting one of a plurality of Shop Bots according to said set of features received
3 from said purchaser.
- 1 100. The method of claim 10 including:
2 receiving from said purchaser an identification of an item about which to provide said
3 detailed information, said identified item selected from a group of individual product items and
4 individual service items.
- 1 101. The method of claim 100 wherein:
2 said detailed information comprises vendor ratings for items in said market segment.
- 1 102. The method of claim 101 including:
2 receiving an order from said purchaser to purchase a selected item.
- 1 103. The method of claim 100 wherein:
2 said detailed information includes comparison shopping information.
- 1 104. The method of claim 103 wherein:
2 said detailed information includes pricing information.
- 1 105. The method of claim 104 including:
2 scouring a wide area network of computers for said pricing information using Shop
3 Bots.
- 1 106. The method of claim 105 wherein:
2 said wide area network of computers comprises vendor memories.
- 1 107. The method of claim 105 wherein:
2 said Shop Bots include a plurality of software agents, each said software agent
3 programmed to focus on one of a plurality of market segments,

4 the method further including selecting a software agent to focus on said selected
5 market segment.

1 108. The method of claim 107 including:
2 receiving from said purchaser an order to purchase a selected item.

1 109. The method of claim 100 including:
2 providing prior customer opinions as part of said detailed information.

1 110. The method of claim 100 including:
2 providing vendor ratings as part of said detailed information.

1 111. The method of claim 100 including:
2 providing pricing information as part of said detailed information.

1 112. The method of claim 111 including:
2 providing pricing for features of items as part of said detailed information.

1 113. The method of claim 111 including:
2 providing pricing plans for services as part of said detailed information.

1 114. The method of claim 111 including:
 scouring a wide area network of computers using Shop Bots for said detailed
information.

1 115. The method of claim 114 including:
2 selecting one of a plurality of software agents, each said software agent programmed
3 to focus on one of said items in said group of individual product items and individual service
4 items,
5 said Shop Bots including said selected software agent.

1 116. The method of claim 115 wherein:
2 said wide area network of computers comprises vendor memories.

- 1 117. The method of claim 7 including:
2 providing procurement suggestions to said purchaser.
- 1 118. The method of claim 14 including:
2 receiving from said purchaser information personal to said purchaser for creation of a
3 customer profile for said purchaser.
- 1 119. The method of claim 118 including:
2 providing said procurement suggestions in a group of formats for selection by said
3 purchaser, said group of formats consisting of profile-based suggestions, quality-based
4 suggestions, quantity-based suggestions, price-based suggestions, and region-based
5 suggestions.
- 1 120. The method of claim 119 including:
2 providing recommendations to said purchaser on a plurality of items related to said
3 selected item based on said customer profile.
- 1 121. The method of claim 10 including:
2 receiving from said purchaser a selection of a research item from said market segment,
3 supplying to said purchaser detailed information on said research item, and
4 providing procurement suggestions to said purchaser.
- 1 122. The method of claim 121 including:
2 requesting information personal to said purchaser for creation of a customer profile for
3 said purchaser, and
4 maintaining a customer profile on said purchaser.
- 1 123. The method of claim 122 wherein:
2 providing said procurement suggestions in a group of formats for selection by said
3 purchaser, said group of formats consisting of profile-based suggestions, quality-based

4 suggestions, quantity-based suggestions, price-based suggestions, popularity-based
5 suggestions, and region-based suggestions.

1 124. The method of claim 123 including:
2 providing recommendations to said purchaser on a plurality of items related to said
3 selected item based on said customer profile.

1 125. The method of claim 1 including:
2 providing detailed information to said purchaser to use to identify said selected item,
3 including in said request a set of customer-defined attributes particular to said selected
4 item.

1 126. The method of claim 125 including:
2 providing said detailed information to said purchaser to identify said customer-defined
3 attributes.

1 127. The method of claim 125 including:
2 processing a reciprocally active bidding negotiation between said purchaser and said
3 vendor in response to submission of said bid.

1 128. The method of claim 1 including:
2 said request having a set of customer-defined attributes particular to said selected
3 item, and
4 processing a reciprocally active bidding negotiation between said purchaser and said
5 vendor in response to submission of said bid.

1 129. The method of claim 128 wherein:
2 said bid comprises an option for said vendor to sell said selected item to another
3 purchaser for a price higher than stated in said bid.

1 130. The method of claim 129 including:

2 said option specifying a time period at the expiration of which the sale of said selected
3 item to said purchaser shall be consummated, that before said expiration seller may sell said
4 selected item to another purchaser for a price higher than stated in said bid, and that if said
5 selected item is sold to said another purchaser, said vendor shall pay a penalty sum to said
6 purchaser.

1 131. The method of claim 130 wherein:

2 said bid includes an inducement for said purchaser to accept said bid, said inducement
3 diminishing over a stated period of time.

1 132. The method of claim 131 wherein:

2 said inducement is a sum, the amount of which is set at the time of acceptance.

1 133. The method of claim 1 including:

2 providing detailed information to said purchaser to use to identify said selected item,
3 and

4 processing a reciprocally active bidding negotiation between said purchaser and said
5 vendor in response to said submission of said bid.

1 134. The method of claim 1 including:

2 providing procurement suggestions to said purchaser, and

3 providing detailed information to said purchaser to use to identify said selected item.

1 135. The method of claim 134 wherein:

2 said information comprises data obtained from third parties regarding purchasing
3 patterns similar to said purchaser's purchasing history.

1 136. The method of claim 1 including:

2 said computer providing procurement suggestions to said purchaser,

3 providing detailed information to said purchaser to use to identify said selected item,

4 said request having a set of customer-defined attributes particular to said selected

5 item, and

6 processing a reciprocally active bidding negotiation between said purchaser and said
7 vendor in response to said submission of said bid.

1 137. The method of claim 136 including:
2 providing said detailed information to said purchaser to identify said customer-defined
3 attributes.

1 138. A method for procurement using a computer that communicates over a network, the
2 method comprising:
3 receiving from a purchaser a request to receive bids to sell a selected item specified
4 from a collection of products and services,
5 sending to said purchaser at least one bid from a vendor to sell said selected item, and
6 processing a reciprocally active bidding negotiation between said purchaser and said
7 vendor in response to said submission of said bid.

1 139. The method of claim 138 including:
2 receiving from said purchaser, included in said request, a set of customer-defined
3 attributes particular to said selected item,
4 sending said request to a plurality of vendors for comparison of said vendor-defined
5 features against said customer-defined attributes for responsiveness to said request, said
6 vendor-defined features maintained by each said vendor in a vendor database, and
7 processing said reciprocally active bidding negotiation between each of said plurality
8 of vendors and said purchaser in response to submission of said bid, said bidding negotiation
9 with each said vendor accessible to every other one of said plurality of vendors and to said
10 purchaser.

1 140. A method for procurement using a computer that communicates over a network, the
2 method comprising:
3 receiving from a purchaser a request to submit bids to sell a selected item specified
4 from a collection of products and services, said request including a set of customer-defined
5 attributes particular to said selected item,

6 sending said request to a plurality of vendors for comparison of said customer-defined
7 attributes against vendor-defined features for responsiveness to said request, said vendor-
8 defined features maintained in a vendor database by each said vendor,
9 sending to said purchaser at least one bid by one of said plurality of vendors to sell
10 said selected item, and
11 processing a reciprocally active bidding negotiation between each of said plurality of
12 vendors which has submitted a bid and said purchaser, said bidding negotiation with each said
13 vendor accessible to every other one of said plurality of vendors and to said purchaser.

1 141. The method of claim 140 including:
2 receiving an acceptance of said bid from said purchaser.

1 142. The method of claim 140 including:
2 receiving said request from an array of networks including a wide-area computer
3 network, a cable television network, and a wireless telephone network.

1 143. The method of claim 140 including:
2 providing detailed information pertinent to said selected item to said purchaser.

1 144. The method of claim 143 including:
2 providing detailed information for said purchaser to use to identify said customer-
3 defined attributes.

1 145. The method of claim 140 including:
2 providing procurement suggestions to said purchaser.

1 146. The method of claim 140 wherein:
2 comparing said vendor-defined features against said customer-defined attributes for
3 responsiveness to said request, said vendor-defined features maintained in a vendor memory.

1 147. The method of claim 146 including:

2 sending a bid to sell said selected item to said purchaser if said vendor-defined features
3 are responsive to said customer-defined attributes.

1 148. The method of claim 146 including:
2 said vendor memory comprising a plurality of sets of vendor-defined features, each
3 said set associated with one of said plurality of vendors, and
4 receiving at predetermined intervals from each of said plurality of vendors an updated
5 set of vendor-defined features for updating said associated set of vendor-defined features.

1 149. The method of claim 140 including:
2 sending said request to a plurality of vendors for comparison of said against said
3 customer-defined attributes for responsiveness to said request, said vendor-defined features
4 maintained by each said vendor in a vendor memory,
5 obtaining from each said vendor an authorization to submit said bid if said vendor-
6 defined features are responsive to said customer-defined attributes, and
7 sending to said purchaser said bid to sell by each said authorizing vendor.

1 150. The method of claim 149 including:
2 issuing said authorization based on preagreed guidelines with said vendor.

1 151. The method of claim 150 wherein:
2 at least one of said vendors is registered with the UDDI business registry.

1 152. The method of claim 150 including:
2 receiving said authorization if said vendor does not reject said request.

1 153. The method of claim 140 including:
2 said collection consisting of (a) basic items including services, products and preset
3 bundles, (b) custom bundles of services, equipment and applications, and (c) made-to-order
4 customized products, and
5 receiving from said purchaser a selection of said selected item from said collection.

1 154. The method of claim 153 wherein:
2 said bid comprises an option for said vendor to sell said selected item to another
3 purchaser for a price higher than stated in said bid.

1 155. The method of claim 154 including:
2 said option specifying a time period at the expiration of which the sale of said selected
3 item to said purchaser shall be consummated, that before said expiration seller may sell said
4 selected item to another purchaser for a price higher than stated in said bid, and that if said
5 selected item is sold to said another purchaser, said vendor shall pay a penalty sum to said
6 purchaser.

1 156. The method of claim 155 wherein:
2 said bid includes an inducement for said purchaser to accept said bid, said inducement
3 diminishing over a stated period of time.

1 157. The method of claim 156 wherein:
2 said inducement is a sum, the amount of which is set at the time of acceptance.

1 158. [deleted]

1 159. The method of claim 153 including:
2 receiving from said purchaser a selection of said selected item from said basic items,
3 said basic items comprising a service group consisting of yield management services,
4 risk management services, and business services, said yield management services comprising
5 travel, telecommunications and energy services, said risk management services comprising
6 financial and insurance services, and said business services comprising technology consulting,
7 corporate and professional services, an equipment group consisting of customized products
8 and industrial parts and subassemblies, said customized products comprising computer,
9 computer software, telecommunications equipment, office product, and high-end consumer
10 electronic equipment product groups, and said industrial parts and subassemblies comprising
11 oil and gas, plastics, rubber, aerospace and aeronautical, automotive, computer,
12 semiconductor and telecommunications product groups, an application bundles group

13 consisting of telecommunications applications services and financial services, said
14 telecommunications applications services comprising integrated telephony, teleconferencing,
15 data, and wireless services, and said financial services comprising automobile, home, business
16 and general financial services, and a service bundles group consisting of yield management
17 services, risk management services, business services, and basic services, said yield
18 management services comprising travel, telecommunications and energy services, said risk
19 management services comprising financial and insurance services, said business services
20 comprising technology consulting, corporate and professional services, and said basic services
21 comprising, local, long distance, wireless and broadband Internet services.

1 160. The method of claim 159 including:

2 receiving from said purchaser an instruction to limit said request by selecting four or
3 more vendors from which to receive said bids.

1 161. A system for procurement that communicates over a network, the system comprising:

2 one or more memory devices configurable for storing (a) an index of individual
3 product items and individual service items, and (b) a plurality of sets of vendor-defined
4 features, each of said set of vendor-defined features associated with a vendor, said index and
5 vendor-defined features being available for access by purchaser nodes,

6 one or more network interfaces adapted to send and receive data to and from
7 purchaser nodes and vendor nodes on a network,

8 one or more processors configured to compare a set of purchaser-defined attributes
9 with said plurality of vendor-defined features for responsiveness to said request, wherein said
10 purchaser-defined attributes are received from a purchaser node in the form of a request to
11 receive bids to sell a selected item from said index, said request including the set of purchaser-
12 defined attributes particular to said selected item, and

13 said processor further configured to submit a bid to said purchaser node upon
14 receiving from at least one of said vendors said bid to sell said selected item, said processor
15 further configured to conduct a reciprocally active bidding negotiation between said purchaser
16 and each of said vendors from which said bid has been received, said bidding negotiation
17 accessible to each said vendor and to said purchaser.

- 1 162. The system of claim 161 including:
2 receiving an acceptance of said bid from one of said purchaser nodes.
- 1 163. The system of claim 161 including:
2 said one or more network interfaces linked to an array of networks including a wide-
3 area computer network, a cable or satellite television network, and a wireless telephone
4 network.
- 1 164. The system of claim 161 including:
2 said processors sending detailed information pertinent to said selected item to said
3 purchaser nodes.
- 1 165. The system of claim 161 including:
2 said processors further configured to generate procurement suggestions to said
3 purchaser,
4 said procurement suggestions being sent to said purchaser.
- 1 166. The system of claim 161 including:
2 said processors further configured to compare said vendor-defined features against
3 said customer-defined attributes for responsiveness to said request.
- 1 167. The system of claim 166 including:
2 said processors further configured to send a bid to sell said selected item to said
3 purchaser node if said vendor-defined features are responsive to said customer-defined
4 attributes.
- 1 168. The system of claim 166 including:
2 each said set of vendor-defined features associated with one of a plurality of vendors,
3 and
4 wherein when at predetermined intervals an updated set of vendor-defined features is
5 received from a vendor node, said processors are further configured to update said associated
6 set of vendor-defined features.

14 data, and wireless services, and said financial services comprising automobile, home, business
15 and general financial services, and a service bundles group consisting of yield management
16 services, risk management services, business services, and basic services, said yield
17 management services comprising travel, telecommunications and energy services, said risk
18 management services comprising financial and insurance services, said business services
19 comprising technology consulting, corporate and professional services, and said basic services
20 comprising, local, long distance, wireless and broadband Internet services.

1 173. The system of claim 172 including:

2 upon receipt of an instruction from said purchaser, said processors are further
3 configured to limit said request by selecting four or more vendors from which to receive said
4 bids.

1 174. A computer program product comprising a machine readable medium on which are
2 provided program instructions for performing a method for procurement using a

3 computer that communicates over a network, the program instructions comprising:
4 program code for receiving from a purchaser a request to receive bids to sell a selected
5 item specified from a collection of products and services,

6 program code for sending to said purchaser at least one bid from a vendor to sell said
7 selected item, and

8 program code for processing an interactive bidding negotiation between said purchaser
9 and said vendor in response to said submission of said bid.

1 175. A method for procurement using a computer that communicates over a network, the
2 method comprising:

3 receiving from each of a plurality of purchasers a request to receive bids to sell a
4 custom bundle, said custom bundle including two or more items, which are selected from the
5 group consisting of a plurality of individual service items, individual equipment items, and
6 individual applications items, said bid comprising a plurality of sub-bids, each said sub-bid for
7 sale of one of said items of said custom bundle,

8 pooling a plurality of said requests from said plurality of purchasers,

9 holding said pooled requests until a specified threshold is attained,

10 upon attaining said threshold, obtaining from said plurality of vendors at least one sub-
11 bid to sell each of said items of said custom bundle, and
12 sending to said purchaser at least one bid to sell said custom bundle, said bid
13 comprising a bundle of sub-bids, each said sub-bid from one of said vendors for sale of one of
14 said items of said custom bundle.

1 176. The method of claim 175 wherein:
2 said plurality of vendors consists of two or more vendors.

1 177. The method of claim 176 including:
2 processing a reciprocally active bidding negotiation between each of said plurality of
3 vendors which has submitted a sub-bid and said purchaser in response to submission of said
4 bid, said bidding negotiation with each said vendor accessible to every other one of said
5 plurality of vendors and to said purchaser.

1 178. A method for procurement using a computer that communicates over a network, the
2 method comprising:
3 receiving from each of a plurality of purchasers a request to receive bids to sell a
4 custom bundle, said custom bundle including two or more items, which are selected from the
5 group consisting of a plurality of individual service items, individual equipment items, and
6 individual applications items, said bid comprising a plurality of sub-bids, each said sub-bid for
7 sale of one of said items of said custom bundle,
8 pooling a plurality of said requests from said plurality of purchasers,
9 holding said pooled requests until a specified threshold is attained,
10 upon attaining said threshold, obtaining from said plurality of vendors at least one sub-
11 bid to sell each of said items,
12 sending to said purchaser at least one bid to sell said custom bundle, said bid
13 comprising a bundle of sub-bids, each said sub-bid from one of said vendors for sale of one of
14 said items of said custom bundle, and
15 processing a reciprocally active bidding negotiation between each of said plurality of
16 vendors which has submitted a sub-bid and said purchaser in response to submission of said

17 bid, said bidding negotiation with each said vendor accessible to every other one of said
18 plurality of vendors and to said purchaser.

1 179. The method of claim 178 wherein:
2 said bid comprises an option for said vendor to sell said selected item to another
3 purchaser for a price higher than stated in said bid.

1 180. The method of claim 179 including:
2 said option specifying a time period at the expiration of which the sale of said selected
3 item to said purchaser shall be consummated, that before said expiration seller may sell said
4 selected item to another purchaser for a price higher than stated in said bid, and that if said
5 selected item is sold to said another purchaser, said vendor shall pay a penalty sum to said
6 purchaser.

1 181. The method of claim 180 wherein:
2 said bid includes an inducement for said purchaser to accept said bid, said inducement
3 diminishing over a stated period of time.

1 182. The method of claim 181 wherein:
2 said inducement is a sum, the amount of which is set at the time of acceptance.

1 183. The method of claim 178 including:
2 processing a reciprocal interactive bidding negotiation between said purchaser and a
3 plurality of vendors in response to a bid by each of said plurality of vendors, and
4 pausing said negotiations with all except one of said plurality of vendors while
5 continuing said negotiation with the remaining vendor.

1 184. The method of claim 178 wherein:
2 said items are selected from a group consisting of [1] yield management services, [2]
3 risk management services, [3] business services, [4a] telecommunications applications
4 services, [4b] basic services, [4c] financial services, [5] customized products, and [6]

5 industrial parts and subassemblies, said yield management services comprising travel,
6 telecommunications and energy services, said risk management services comprising financial
7 and insurance services, said business services comprising technology consulting, corporate
8 and professional services, said telecommunications applications services comprising integrated
9 telephony, teleconferencing, data, and wireless services, said basic services comprising, local,
10 long distance, wireless and broadband Internet services, said financial services comprising
11 automobile, home, business and general financial services, said customized products
12 comprising computer, computer software, telecommunications equipment, office product, and
13 high-end consumer electronic equipment product groups, and said industrial parts and
14 subassemblies comprising oil and gas, plastics, rubber, aerospace and aeronautical,
15 automotive, computer, semiconductor and telecommunications product groups.

1 185. The method of claim 178 wherein:
2 said specified threshold comprises a waiting period.

1 186. The method of claim 185 including:
2 receiving from each of said plurality of purchasers a specified waiting period.

1 187. The method of claim 186 wherein:
2 said waiting period is selected from a group of periods consisting of immediately, one
3 day three days, and at least three days.

1 188. The method of claim 187 including:
2 pooling said requests by clustering together said requests according to said selected
3 waiting period.

1 189. The method of claim 178 wherein:
2 said threshold comprises a minimum quantity of requests.

1 190. The method of claim 184 wherein:
2 said plurality of vendors consists of two or more vendors.

- 1 191. The method of claim 190 wherein:
2 said request specifies a set of customer-defined attributes particular to each item.
- 1 192. The method of claim 191 including:
2 comparing said vendor-defined features for said item against said customer-defined
3 attributes for each item for responsiveness to said request.
- 1 193. The method of claim 192 including:
2 maintaining said vendor-defined features in a vendor memory.
- 1 194. The method of claim 192 including:
2 providing to said purchaser a sub-bid for each said item if said vendor-defined features
3 are responsive to said customer-defined features.
- 1 195. The method of claim 194 including:
2 said vendor memory comprising a plurality of sets of vendor-defined features, each
3 said set associated with one of said plurality of vendors, and
4 receiving from each of said plurality of vendors update information for updating said
5 associated set of vendor-defined features.
- 1 196. The method of claim 191 including:
2 sending said request to a plurality of vendors for comparison of said vendor-defined
3 features against said customer-defined attributes for responsiveness to said request, said
4 vendor-defined features maintained in a vendor memory by each said vendor,
5 receiving from each said vendor an authorization if said vendor-defined features are
6 responsive to said customer-defined attributes, and
7 sending said bid to sell said custom bundle if a sub-bid is produced by one of said
8 plurality of vendors for each said item.
- 1 197. The method of claim 196 including:
2 linking to each said vendor,

3 receiving said authorization from each said vendor if said vendor-defined features are
4 responsive to said customer-defined attributes.

1 198. The method of claim 197 wherein:
2 said linking is performed using Extensible Markup Language.

1 199. The method of claim 197 including:
2 at least one of said plurality of vendors registering with the UDDI business registry.

1 200. The method of claim 190 wherein:
2 each said sub-bid is associated with one of said two or more vendors, and
3 said method further includes receiving from said purchaser a rejection of at least one
4 of said sub-bids, and receiving from said purchaser a counter-bid to said associated vendor to
5 replace said rejected sub-bid.

1 201. The method of claim 200 including:
2 said counter-bid including and based on a revised set of said customer-defined
3 attributes.

1 202. The method of claim 200 including:
2 receiving from said associated vendor an acceptance of said counter-bid.

1 203. The method of claim 200 including:
2 receiving from said associated vendor a counter-counter-bid responsive to said
3 purchaser's counter-bid, and
4 submitting said counter-counter-bid to said purchaser.

1 204. The method of claim 203 including:
2 receiving an acceptance to said counter-counter-bid from said purchaser.

1 205. A system for procurement that communicates over a network, the system comprising:

2 a memory for storing in an index comprising individual product items, individual
3 service items, and individual applications items,

4 a network interface allowing a purchaser to access said index, and for receiving from
5 each of a plurality of purchasers requests to submit bids to sell custom bundles, each of said
6 custom bundles including two or more items which are selected from said index,

7 a processor configured to accumulate items from a plurality of said requests into pools
8 of items until at least one of said pools of items attains a predetermined threshold, and upon
9 attaining said threshold to send said at least one pools of items to a plurality of vendors,

10 said processor also configured to submit to said purchaser a bid to sell at least one
11 item from said custom bundle upon receiving from at least one of said plurality of vendors the
12 bid,

13 said processor further configured or designed to conduct a reciprocally active bidding
14 negotiation between said purchaser and each said vendor having submitted a bid, said bidding
15 negotiation accessible to each said vendor and to said purchaser.

1 206. The system of claim 205 wherein:

2 when bids from at least two of said plurality of vendors are received, said processor is
3 further configured to process a reciprocally active bidding negotiation between said purchaser
4 and each of said plurality of vendors which has submitted a bid, said bidding negotiation
5 accessible to each said vendor and to said purchaser.

1 207. The system of claim 1206 wherein:

2 said items are selected from a group consisting of [1] yield management services, [2]
3 risk management services, [3] business services, [4a] telecommunications applications
4 services, [4b] basic services, [4c] financial services, [5] customized products, and [6]
5 industrial parts and subassemblies, said yield management services comprising travel,
6 telecommunications and energy services, said risk management services comprising financial
7 and insurance services, said business services comprising technology consulting, corporate
8 and professional services, said telecommunications applications services comprising integrated
9 telephony, teleconferencing, data, and wireless services, said basic services comprising, local,
10 long distance, wireless and broadband Internet services, said financial services comprising
11 automobile, home, business and general financial services, said customized products

12 comprising computer, computer software, telecommunications equipment, office product, and
13 high-end consumer electronic equipment product groups, and said industrial parts and
14 subassemblies comprising oil and gas, plastics, rubber, aerospace and aeronautical,
15 automotive, computer, semiconductor and telecommunications product groups.

1 208. The system of claim 206 wherein:
2 said specified threshold comprises a waiting period.

1 209. The system of claim 208 wherein:
2 said processor is configured to receive a specified waiting period from each of said
3 plurality of purchasers.

1 210. The system of claim 209 wherein:
2 said waiting period is selected from a group of periods consisting of immediately, one
3 day three days, and at least three days.

1 211. The system of claim 210 wherein:
2 said pooling is performed by clustering together said requests according to said
3 selected waiting period.

1 212. The system of claim 206 wherein:
2 said threshold comprises a minimum quantity of requests.

1 213. The system of claim 207 wherein:
2 said plurality of vendors consists of two or more vendors.

1 214. The system of claim 213 wherein:
2 a request includes a specified set of customer-defined attributes particular to each
3 item.

1 215. The system of claim 214 including:
2 said processor configured to compare said vendor-defined features for each said item

3 against said customer-defined attributes for said item for responsiveness to said request.

1 216. The system of claim 215 including:
2 said vendor-defined features maintained in said memory.

1 217. The system of claim 215 including:
2 said processor configured to provide to said purchaser a sub-bid for each said item if
3 said vendor-defined features are responsive to said customer-defined features.

1 218. The system of claim 217 including:
2 said vendor-defined features comprising a plurality of sets of vendor-defined features,
3 each said set associated with one of said plurality of vendors, and
4 said processor configured to update said associated set of vendor-defined features
5 upon receiving update information from one of said plurality of vendors.

1 219. The system of claim 214 wherein:
2 said processor is configured to send said request to a plurality of vendors for
3 comparison of said vendor-defined features against said customer-defined attributes for
4 responsiveness to said request, said vendor-defined features maintained in a vendor memory
5 by each said vendor, to receive from each said vendor an authorization if said vendor-defined
6 features are responsive to said customer-defined attributes, and to provide said bid to sell said
7 custom bundle to said purchaser if a sub-bid is produced by one of said plurality of vendors
8 for each said item.

1 220. The system of claim 219 wherein:
2 said network interface is linked electronically to a vendor node for each said vendor.

1 221. The system of claim 220 wherein:
2 said link is performed using Extensible Markup Language.

1 222. The system of claim 220 wherein:
2 said processor is configured or designed to favor vendors registered with the UDDI

3 business registry.

1 223. The system of claim 213 wherein:
2 each said sub-bid is associated with one of said two or more vendors, and
3 said processor is further configured or designed to receive from said purchaser a
4 rejection of at least one of said sub-bids, and a counter-bid from said purchaser to said
5 associated vendor to replace said rejected sub-bid, and to provide said counter-bid to said
6 vendor.

1 224. A computer program product comprising a machine readable medium on which is
2 provided program instructions for performing a method for procurement using a
3 computer that communicates over a network, the program instructions comprising:
4 program code for receiving from each of a plurality of purchasers a request to receive
5 bids to sell a custom bundle, said custom bundle including two or more items, which are
6 selected from the group consisting of a plurality of individual service items, individual
7 equipment items, and individual applications items, said bid comprising a plurality of sub-bids,
8 each said sub-bid for sale of one of said items of said custom bundle,
9 program code for pooling a plurality of said requests said plurality of purchasers,
10 program code for holding said pooled requests until a specified threshold attained,
11 program code for upon attaining said threshold, obtaining from said plurality of
12 vendors at least one sub-bid to sell each of said items of said custom bundle,
13 program code for sending to said purchaser at least one bid to sell said custom bundle,
14 said bid comprising a sub-bid for each said item of said custom bundle, and
15 program code for processing a reciprocally active bidding negotiation between each of
16 said plurality of vendors which has submitted a sub-bid and said purchaser in response to
17 submission of said bid, said bidding negotiation with each said vendor accessible to every
18 other one of said plurality of vendors and to said purchaser.

1 225. A method for procurement using a computer that communicates over a network, the
2 method comprising:
3 receiving from a purchaser a request to receive bids to sell a made-to-order
4 customized product, said request including a set of characteristics describing said purchaser,

5 processing said set of characteristics into product features,
6 said made-to-order customized product comprises a plurality of component parts
7 selected from a group consisting of individual service items, individual equipment items and
8 individual applications items, each said component part selected for compliance with said
9 product features,
10 obtaining from said plurality of vendors at least one sub-bid to sell each of said
11 component parts, and
12 submitting to said purchaser at least one bid to sell said made-to-order customized
13 product, said bid comprising a plurality of sub-bids, each said sub-bid from one of said
14 vendors for sale of one of said component parts of said made-to-order customized product.

1 226. The method of claim 225 including:
2 said bid offers a reduced per-item price for selling at least a minimum number of said
3 selected items.

1 227. A system for procurement using a computer that communicates over a network, the
2 system comprising:
3 one or more network interfaces adapted to send and receive data to and from
4 purchaser nodes and vendor nodes on a network, said data including (a) a request from a
5 purchaser node to submit bids to sell a made-to-order customized product, said made-to-order
6 customized product comprising a plurality of component parts, said request including a
7 description of said purchaser, and (b) a sub-bid to sell each of said plurality of component
8 parts selected for compliance with product features including at least one of individual
9 customized product items and individual customized service items, and
10 a processor configured or designed to convert said description into said product
11 features.

1 228. The system of claim 1, wherein the processor is designed or configured to submit said
2 request, including said product features, to a plurality of vendors, said processor also
3 configured or designed to receive the sub-bid from a vendor node and submit that sub-
4 bid to the purchaser.

- 1 229. The system of claim 1, wherein said processor is designed or configured to prepare at
2 least one bid consisting of one said sub-bid to sell each said component part of said
3 made-to-order customized product, said bid being delivered to said purchaser.
- 1 230. A computer program product comprising a machine readable medium on which is
2 provided program instructions for performing a method for procurement using a
3 computer that communicates over a network, the program instructions comprising:
4 program code for receiving from a purchaser a request to receive bids to sell a made-
5 to-order customized product, said request including a set of features describing said
6 purchaser,
7 program code for processing said set of features into product features,
8 program code for said made-to-order customized product comprises a plurality of
9 component parts selected from a group consisting of individual service items, individual
10 equipment items and individual applications items, each said component part selected for
11 compliance with said product features,
12 program code for obtaining from said plurality of vendors at least one sub-bid to sell
13 each of said component parts, and
14 program code for submitting to said purchaser at least one bid to sell said made-to-
15 order customized product, said bid comprising a plurality of sub-bids, each said sub-bid from
16 one of said vendors for sale of one of said component parts of said made-to-order customized
17 product.
- 1 231. A method for procurement using a computer that communicates over a network, the
2 method comprising:
3 providing detailed information to a purchaser to use to identify a selected item,
4 receiving from a purchaser a request to receive bids to sell said selected item, said
5 request including a set of customer-defined attributes particular to said selected item,
6 receiving at least one bid to sell said selected item from at least one vendor, and
7 submitting said bid to said purchaser.
- 8 232. The method of claim 231 wherein:
9 said bid comprises an option for said vendor to sell said selected item to another

10 purchaser for a price higher than stated in said bid.

1 233. The method of claim 232 including:

2 said option specifying a time period at the expiration of which the sale of said selected
3 item to said purchaser shall be consummated, that before said expiration seller may sell said
4 selected item to another purchaser for a price higher than stated in said bid, and that if said
5 selected item is sold to said another purchaser, said vendor shall pay a penalty sum to said
6 purchaser.

1 234. The method of claim 233 wherein:

2 said bid includes an inducement for said purchaser to accept said bid, said inducement
3 diminishing over a stated period of time.

1 235. The method of claim 234 wherein:

2 said inducement is a sum, the amount of which is set at the time of acceptance.

1 236. The method of claim 231 wherein:

2 said selected item is selected from an index of individual product items, individual
3 service items, and individual bundles, each said bundle comprising two or more items selected
4 from a group of individual product items and individual service items.

1 237. The method of claim 231 including:

2 receiving from said purchaser a description of features desired by said purchaser in a
3 product item, service item, or bundle, and
4 identifying said product item, service item, or bundle using said description of features.

1 238. The method of claim 231 including:

2 obtaining said detailed information from a third party information vendor.

1 239. The method of claim 231 including:

2 receiving from said purchaser a selection of product and service items about which to
3 obtain detailed information.

1 240. The method of claim 239 wherein:
2 said product and service items comprise [1] yield management services, [2] risk
3 management services, [3] business services, [4a] telecommunications applications services,
4 [4b] basic services, [4c] financial services, [5] customized products, and [6] industrial parts
5 and subassemblies, said yield management services comprising travel, telecommunications and
6 energy services, said risk management services comprising financial and insurance services,
7 and said business services comprising technology consulting, corporate and professional
8 services, said telecommunications applications services comprising integrated telephony,
9 teleconferencing, data, and wireless services, said basic services comprising, local, long
10 distance, wireless and broadband Internet services, said financial services comprising
11 automobile, home, business and general financial services, said customized products
12 comprising computer, computer software, telecommunications equipment, office product, and
13 high-end consumer electronic equipment product groups, and said industrial parts and
14 subassemblies comprising oil and gas, plastics, rubber, aerospace and aeronautical,
15 automotive, computer, semiconductor and telecommunications product groups.

1 241. The method of claim 231 including:
2 providing said detailed information to said purchaser to identify said customer-defined
3 attributes.

1 242. The method of claim 240 wherein:
2 said detailed information includes consumer ratings.

1 243. The method of claim 240 wherein:
2 said detailed information includes pricing information.

1 244. The method of claim 243 including:
2 scouring a global computer network for said pricing information using Shop Bots.

1 245. The method of claim 240 wherein:
2 said detailed information includes comparison shopping information.

1 246. The method of claim 240 wherein:
2 said detailed information includes vendor ratings.

1 247. A system for procurement that communicates over a network, the system comprising:
2 a memory for storing information on at least one of (a) an identified product item, (b)
3 an identified service item, and (c) an identified bundle of two or more items including at least
4 one of a product item and a service item,
5 one or more network interfaces adapted to send and receive data to and from
6 purchaser nodes and vendor nodes on a network, and allowing access by said purchaser nodes
7 to detailed information, and for receiving from a purchaser node a request to submit bids to
8 sell a selected item, said detailed information allowing a purchaser using said purchaser node
9 to identify said selected item in said request by a set of purchaser-defined attributes particular
10 to said selected item, and
11 one or more processors designed or configured to submit a request identifying the
12 selected item to a plurality of vendors, and, upon receiving from at least one vendor bid to sell
13 said selected item, submitting a bid to sell said selected item to the purchaser node.

1 248. The system of claim 247 including:
2 said processor configured or designed to provide said detailed information to said
3 purchaser upon receipt from said purchaser of features desired in a product or service item.

1 249. The system of claim 247 including:
2 said processor configured or designed to provide said detailed information upon
3 receipt from said purchaser of an identification of a generic product or service upon which to
4 provide said detailed information.

1 250. The system of claim 249 wherein:
2 said generic product or service comprises [1] yield management services, [2] risk
3 management services, [3] business services, [4a] telecommunications applications services,
4 [4b] basic services, [4c] financial services, [5] customized products, and [6] industrial parts
5 and subassemblies, said yield management services comprising travel, telecommunications and

6 energy services, said risk management services comprising financial and insurance services,
7 and said business services comprising technology consulting, corporate and professional
8 services, said telecommunications applications services comprising integrated telephony,
9 teleconferencing, data, and wireless services, said basic services comprising, local, long
10 distance, wireless and broadband Internet services, said financial services comprising
11 automobile, home, business and general financial services, said customized products
12 comprising computer, computer software, telecommunications equipment, office product, and
13 high-end consumer electronic equipment product groups, and said industrial parts and
14 subassemblies comprising oil and gas, plastics, rubber, aerospace and aeronautical,
15 automotive, computer, semiconductor and telecommunications product groups.

1 251. The system of claim 247 including:
2 said purchaser using said detailed information to identify said customer-defined
3 attributes.

1 252. The system of claim 250 wherein:
2 said detailed information includes consumer ratings.

1 253. The system of claim 250 wherein:
2 said detailed information includes pricing information.

1 254. The system of claim 253 including:
2 scouring a global computer network for said pricing information using Shop Bots.

1 255. The system of claim 250 wherein:
2 said detailed information includes comparison shopping information.

1 256. The system of claim 250 wherein:
2 said detailed information includes vendor ratings.

1 257. A computer program product comprising a machine readable medium on which is
2 provided program instructions for performing a method for procurement using a

3 computer that communicates over a network, the program instructions comprising:
4 program code for providing detailed information on an identified product item, service
5 item, or bundle of two or more items selected from a group of product items and service items
6 to a purchaser to use to identify a selected item,
7 program code for receiving from a purchaser a request to receive bids to sell said
8 selected item, said request including a set of customer-defined attributes particular to said
9 selected item,
10 program code for receiving at least one bid to sell said selected item from at least one
11 vendor, and
12 program code for submitting said bid to said purchaser.

1 258. A method for procurement using a computer that communicates over a network, the
2 method comprising:
3 providing detailed information for a purchaser to use to identify a selected item,
4 receiving from said purchaser a request to receive bids to sell said selected item,
5 obtaining at least one bid to sell said selected item from at least one of a plurality of
6 vendors,
7 submitting said bid to said purchaser, and
8 processing an interactive bidding negotiation between said purchaser and said vendor
9 in response to said submission of said bid.

1 259. The method of claim 258 wherein:
2 said bid comprises an option for said vendor to sell said selected item to another
3 purchaser for a price higher than stated in said bid.

1 260. The method of claim 259 including:
2 said option specifying a time period at the expiration of which the sale of said selected
3 item to said purchaser shall be consummated, that before said expiration seller may sell said
4 selected item to another purchaser for a price higher than stated in said bid, and that if said
5 selected item is sold to said another purchaser, said vendor shall pay a penalty sum to said
6 purchaser.

1 261. The method of claim 260 wherein:
2 said bid includes an inducement for said purchaser to accept said bid, said inducement
3 diminishing over a stated period of time.

1 262. The method of claim 261 wherein:
2 said inducement is a sum, the amount of which is set at the time of acceptance.

3 263. The method of claim 258 wherein:
4 said request includes a set of customer-defined attributes particular to said selected
5 item,
6 maintaining a plurality of sets of vendor-defined item features, each said set of vendor-
7 defined item features associated with a plurality of items available for sale by a vendor, and
8 processing a comparison of said customer-defined attributes with said vendor-defined
9 item features for responsiveness to said request.

1 264. The method of claim 258 including:
2 obtaining said detailed information from a third party information vendor.

1 265. The method of claim 258 including:
2 receiving from said purchaser features desired in a product or service item.

1 266. The method of claim 258 including:
2 receiving from said purchaser a selection of product and service items about which to
3 obtain detailed information.

1 267. The method of claim 258 including:
2 providing said detailed information for said purchaser to identify said customer-defined
3 attributes.

1 268. The method of claim 267 wherein:
2 said detailed information includes consumer ratings.

- 1 269. The method of claim 267 wherein:
2 said detailed information includes pricing information.
- 1 270. The method of claim 269 including:
2 scouring a global computer network for said pricing information using Shop Bots.
- 1 271. The method of claim 267 wherein:
2 said detailed information includes comparison shopping information.
- 1 272. The method of claim 267 wherein:
2 said detailed information includes vendor ratings.
- 1 273. A system for procurement that communicates over a network, the system comprising:
2 one or more memory devices on which is provided information on at least one of an
3 identified product item, an identified service item, and a bundle of two or more items including
4 at least one of a product item and a service item,
5 one or more network interfaces adapted to send and receive data to and from
6 purchaser nodes and vendor nodes on a network, the data including (a) requests from said
7 purchaser nodes to submit bids and (b) vendor bids from said vendor nodes, the network
8 interface allowing a purchaser using a purchaser node to access the information provided on
9 the one or more memory devices and thereby identify a selected item using said information,
10 one or more processors configured or designed to submit requests, to a plurality of
11 vendor nodes, for bids to sell said selected item, said one or more processors also configured
12 or designed to submit to said purchaser node a bid to sell said selected item, which bid was
13 received from a vendor node,
14 said one or more processors further configured for processing an interactive bidding
15 negotiation between said purchaser and said vendor in response to said submission of said bid.
- 1 274. The system of claim 273 including:
2 said processor configured or designed to provide said information to said purchaser
3 upon receipt from said purchaser of features desired in a product or service item.

- 1 275. The system of claim 273 including:
2 said processor configured or designed to provide said information upon receipt from
3 said purchaser of a selection of product and service items about which to obtain said
4 information.
- 1 276. The system of claim 273 including:
2 said computer providing said information to said purchaser to identify said customer-
3 defined attributes.
- 1 277. The system of claim 273 wherein:
2 said information includes consumer ratings.
- 1 278. The system of claim 273 wherein:
2 said information includes pricing information.
- 1 279. The system of claim 278 including:
2 scouring a global computer network for said pricing information using Shop Bots.
- 1 280. The system of claim 276 wherein:
2 said information includes comparison shopping information.
- 1 281. The system of claim 276 wherein:
2 said information includes vendor ratings.
- 1 282. A computer program product comprising a machine readable medium on which is
2 provided program instructions for performing a method for procurement using a
3 computer that communicates over a network, the program instructions comprising:
4 program code for providing detailed information on an identified product item, service
5 item, or bundle of two or more items selected from a group of product items and service items
6 to a purchaser for said purchaser to use to identify a selected item,
7 program code for receiving from said purchaser a request to receive bids to sell said
8 selected item,

9 program code for obtaining at least one bid to sell said selected item from at least one
10 of a plurality of vendors,
11 program code for submitting said bid to said purchaser, and
12 program code for processing an interactive bidding negotiation between said purchaser
13 and said vendor in response to said submission of said bid.

1 283. A method for procurement using a computer that communicates over a network, the
2 method comprising:
3 providing detailed information on an identified product item, service item, or bundle of
4 two or more items selected from a group of product items and service items to a purchaser for
5 said purchaser to use to identify a selected item, and
6 receiving from said purchaser a request to receive bids to sell said selected item, said
7 request including a set of customer-defined attributes particular to said selected item,
8 maintaining a plurality of sets of vendor-defined item features, each said set of vendor-
9 defined item features associated with a plurality of items available for sale by a vendor,
10 processing a comparison of said customer-defined attributes with said vendor-defined
11 item features for responsiveness to said request,
12 receiving at least one bid to sell said selected item from at least one of a plurality of
13 vendors,
14 sending said bid to said purchaser, and
15 processing an interactive bidding negotiation between said purchaser and said vendor
16 in response to submission of said bid.

1 284. The method of claim 283 wherein:
2 said bid comprises an option for said vendor to sell said selected item to another
3 purchaser for a price higher than stated in said bid.

1 285. The method of claim 284 including:
2 said option specifying a time period at the expiration of which the sale of said selected
3 item to said purchaser shall be consummated, that before said expiration seller may sell said
4 selected item to another purchaser for a price higher than stated in said bid, and that if said
5 selected item is sold to said another purchaser, said vendor shall pay a penalty sum to said

6 purchaser.

1 286. The method of claim 285 wherein:
2 said bid includes an inducement for said purchaser to accept said bid, said inducement
3 diminishing over a stated period of time.

1 287. The method of claim 286 wherein:
2 said inducement is a sum, the amount of which is set at the time of acceptance.

1 288. The method of claim 283 including:
2 obtaining said detailed information from a third party information vendor.

1 289. The method of claim 283 including:
2 receiving from said purchaser an identification of a product or service item about
3 which to obtain detailed information, said product or service item described by desired
4 features.

1 290. The method of claim 283 including:
2 said product or service item comprises a generic product or service item.

1 291. The method of claim 283 wherein:
2 said detailed information includes consumer ratings.

1 292. The method of claim 283 wherein:
2 said detailed information includes pricing information.

1 293. The method of claim 292 including:
2 scouring a global computer network for said pricing information using Shop Bots.

1 294. The method of claim 291 wherein:
2 said detailed information includes comparison shopping information.

- 1 295. The method of claim 291 wherein:
2 said detailed information includes vendor ratings.
- 1 296. A system for procurement that communicates over a network, the system comprising:
2 one or more network interfaces adapted to send and receive data to and from
3 purchaser nodes and vendor nodes on a network, allowing a purchaser to access information
4 on an identified product item, service item, or bundle of two or more items including at least
5 one of a product items and service items, the one or more network interfaces allowing the
6 system to receive from said purchaser node a request to submit bids to sell a selected item,
7 identified by a purchaser using said information, and
8 a processor configured or designed for submitting to said purchaser node at least one
9 bid from one of a plurality of vendors to sell said selected item and for conducting an
10 interactive bidding negotiation between said purchaser and said vendor in response to
11 submission of said bid.
- 12 297. The system of claim 296 including:
13 when features desired in a product or service item are received from a purchaser node,
14 said processor configured to identify said selected item by said features.
- 1 298. The system of claim 296 including:
2 said selected item being identified from a selection by said purchaser from a list of
3 product and service items resident in a system memory.
- 1 299. The system of claim 298 wherein:
2 said information includes consumer ratings.
- 1 300. The system of claim 298 wherein:
2 said information includes pricing information.
- 1 301. The system of claim 299 including:
2 scouring a global computer network for said pricing information using Shop Bots.

- 1 302. The system of claim 298 wherein:
2 said information includes comparison shopping information.
- 1 303. The system of claim 298 wherein:
2 said information includes vendor ratings.
- 1 304. A computer program product comprising a machine readable medium on which is
2 provided program instructions for performing a method for procurement using a
3 computer that communicates over a network, the program instructions comprising:
4 program code for providing detailed information on an identified product item, service
5 item, or bundle of two or more items selected from a group of product items and service items
6 to a purchaser for said purchaser to use to identify of a selected item, and
7 program code for receiving from said purchaser a request to receive bids to sell said
8 selected item,
9 program code for receiving at least one bid to sell said selected item from at least one
10 of a plurality of vendors,
11 program code for submitting said bid to said purchaser, and
12 program code for processing an interactive bidding negotiation between said purchaser
13 and said vendor in response to submission of said bid.
- 1 305. A method for procurement using a computer that communicates over a network, the
2 method comprising:
3 providing procurement suggestions to a purchaser,
4 providing detailed information on an identified product item, service item, or bundle of
5 two or more items selected from a group of product items and service items to a purchaser to
6 use to identify a selected item,
7 receiving a request from said purchaser to receive bids to sell said selected item,
8 obtaining at least one bid from a vendor to sell said selected item, and
9 submitting said bid to said purchaser.
- 1 306. The method of claim 304 including:
2 obtaining said detailed information from a third party information vendor.

- 1 307. The method of claim 304 including:
2 accumulating data regarding said purchaser's purchasing history to form a consumer
3 profile for said purchaser,
4 said procurement suggestions include predictions of product or service items said
5 purchaser may wish to procure based on said consumer profile.
- 1 308. The method of claim 15 wherein:
2 said data comprises data obtained from third parties regarding purchasing patterns
3 similar to said purchaser's purchasing history.
- 1 309. A system for procurement that communicates over a network, the system comprising:
2 one or more network interfaces adapted to send and receive data to and from
3 purchaser nodes and vendor nodes on a network, and allowing a purchaser node to access
4 information on an identified product item, service item, or bundle of two or more items
5 including at least one of a product items and a service items,
6 a processor designed or configured to prepare and submit suggestions-for procurement
7 of product items and service items in response to inquiries received from the purchaser node,
8 said processor also designed or configured to identify a selected item upon receipt of a request
9 to submit bids from said purchaser node and then, upon receipt of at least one bid from one of
10 a plurality of vendor nodes to sell said selected item,-submitting said bid to said purchaser.
- 1 310. A computer program product comprising a machine readable medium on which is
2 provided program instructions for performing a method for procurement using a
3 computer that communicates over a network, the program instructions comprising:
4 program code for providing procurement suggestions to a purchaser,
5 program code for providing detailed information on an identified product item, service
6 item, or bundle of two or more items selected from a group of product items and service items
7 to a purchaser to use to identify a selected item,
8 program code for receiving a request from said purchaser to receive bids to sell said
9 selected item,
10 program code for obtaining at least one bid from a vendor to sell said selected item,

11 and

12 program code for submitting said bid to said purchaser.

1 311. A method for procurement using a computer that communicates over a network, the
2 method comprising:
3 providing information on a collection of items and vendors to a purchaser,
4 receiving a purchaser's selection of two or more vendors,
5 receiving a set of customer-defined attributes from said purchaser,
6 presenting said customer-defined attributes to said two or more selected vendors,
7 receiving bids from at least two of said vendors,
8 delivering said bids to said purchaser, and
9 processing a negotiation between said purchaser and said vendors.

10 312. The method of claim 311 wherein:
11 said bid comprises an option for said vendor to sell said selected item to another
12 purchaser for a price higher than stated in said bid.

1 313. The method of claim 312 including:
2 said option specifying a time period at the expiration of which the sale of said selected
3 item to said purchaser shall be consummated, that before said expiration seller may sell said
4 selected item to another purchaser for a price higher than stated in said bid, and that if said
5 selected item is sold to said another purchaser, said vendor shall pay a penalty sum to said
6 purchaser.

314. The method of claim 313 wherein:
said bid includes an inducement for said purchaser to accept said bid, said inducement
diminishing over a stated period of time.

315. The method of claim 314 wherein:
said inducement is a sum, the amount of which is set at the time of acceptance.

1 316. A system for procurement that communicates over a network, the system comprising:

2 one or more memory devices;
3 one or more processors in communication with said one or more processor devices;
4 one or more network interfaces adapted to send and receive data to and from
5 purchaser nodes and vendor nodes on a network,
6 wherein at least one of the processors and memory devices make available to a
7 purchaser node information about a collection of items and vendors to a purchaser, and
8 wherein when the system receives a selection of two or more vendors and a set of purchaser-
9 defined attributes from said purchaser node, the processor presents the purchaser-defined
10 attributes to vendor nodes for the two or more selected vendors, and wherein when the
11 system receives bids from at least two vendor nodes, the processor presents the bids to the
12 purchaser node,
13 the processor further conducting a negotiation between said purchaser and said
14 vendors.

1 317. A computer program product comprising a machine readable medium on which is
2 provided program instructions for performing a method for procurement using a
3 computer that communicates over a network, the program instructions comprising:
4 program code for providing information on a collection of items and vendors to a
5 purchaser,
6 program code for receiving a purchaser's selection of two or more vendors,
7 program code for receiving a set of customer-defined attributes from said purchaser,
8 program code for presenting said customer-defined attributes to said vendors,
9 program code for receiving bids from said vendors,
10 program code for delivering said bid to said purchaser, and
11 program code for processing a negotiation between said purchaser and said vendors.

1 318. A method for procurement using a computer that communicates over a network, the
2 method comprising:
3 receiving from each of a plurality of sellers an identification of an identified item for
4 sale by said seller, each said item identified by a set of item features,
5 maintaining a list of said identified items in an index of individual product items and
6 individual service items,

7 receiving from one of a plurality of purchasers a request to receive bids to sell one of
8 said individual product and service items, said request including a set of item attributes desired
9 in said item,
10 comparing said item attributes with said item features for responsiveness to said
11 request,
12 selecting at least one selected item from said list as being responsive to said request,
13 providing at least one bid to said purchaser, said bid from one of said plurality of
14 sellers to sell said selected item, and
15 conducting a reciprocally active bidding negotiation between said purchaser and said
16 seller.

1 319. The method of claim 318 wherein:
2 said bid comprises an option for said vendor to sell said selected item to another
3 purchaser for a price higher than stated in said bid.

1 320. The method of claim 319 including:
2 said option specifying a time period at the expiration of which the sale of said selected
3 item to said purchaser shall be consummated, that before said expiration seller may sell said
4 selected item to another purchaser for a price higher than stated in said bid, and that if said
5 selected item is sold to said another purchaser, said vendor shall pay a penalty sum to said
6 purchaser.

1 321. The method of claim 320 wherein:
2 said bid includes an inducement for said purchaser to accept said bid, said inducement
3 diminishing over a stated period of time.

1 322. The method of claim 321 wherein:
2 said inducement is a sum, the amount of which is set at the time of acceptance.

3 323. The method of claim 318 including:
4 receiving an acceptance from said purchaser to one of said at least one bids.

- 1 324. The method of claim 318 including:
2 receiving said request from one of a plurality of networks, said plurality of networks
3 including a wide area network of computers, a cable television network, and wireless
4 telephone network.
- 1 325. The method of claim 318 wherein:
2 said request includes a set of customer-defined attributes particular to said item.
326. The method of claim 318 including:
providing information for said purchaser to use to identify said item.
- 1 327. The method of claim 318 including:
2 providing procurement suggestions to said purchaser.
- 1 328. The method of claim 318 including:
2 accumulating information regarding said purchaser's purchasing history to form a
3 customer profile for said purchaser,
4 said procurement suggestions include predictions of product or service items said
5 purchaser may wish to procure based on said purchasing history.
- 1 329. The method of claim 318 including:
2 one or more of said plurality of vendors is registered with the UDDI business registry,
3 and said one or more vendors are favored in said comparing process.
- 1 330. The method of claim 318 including:
2 said comparing is performed using Extensible Markup Language.
- 1 331. The method of claim 318 including:
2 said comparing is performed using hypertext markup language.
- 1 332. The method of claim 318 including:
2 receiving from said purchaser a counter-offer to one of said at least one bids.

- 1 333. The method of claim 332 including:
2 receiving an acceptance from a vendor to said counter-offer.
- 1 334. The method of claim 318 including:
2 receiving a request for new bids from said purchaser, and
3 receiving a new bid from each of at least one of said vendors.
- 1 335. The method of claim 318 including:
2 receiving an acceptance from said purchaser to said at least one bid.
- 1 336. The method for procurement of claim 318 wherein:
2 said index comprises yield management services, customized products, miscellaneous
3 or used products, small business services, and personnel and management resource services.
- 1 337. The method for procurement of claim 336 wherein:
2 said yield management services comprise travel, telecommunications and energy
3 services.
- 1 338. The method for procurement of claim 336 wherein:
2 said customized products comprise computer, computer software, telecommunications
3 equipment, office product, and consumer electronic equipment product groups.
- 1 339. The method for procurement of claim 336 wherein:
2 said miscellaneous, or used products comprise computers, office equipment, audio and
3 video equipment, antiques, carpets, photography equipment, autos and trucks, industrial
4 equipment, CDS and DVDs, collectibles, watches and jewelry, art objects, memorabilia,
software or books on demand, music on demand, or videos on demand.
- 1 340. The method for procurement of claim 336 wherein:
2 said small business services comprise plumbing, electrical, gardening, household
3 repair, technology advice and repair (e.g., computers, communications), and desktop

4 publishing.

1 341. The method for procurement of claim wherein:

2 said personnel and management resource services comprise general management (e.g.,
3 senior executives, administrators and middle management), health and medicine (e.g., medical
4 doctors, nurses), information technology, science and engineering (e.g., scientists and
5 technologists), manufacturing, professionals (e.g., lawyers, strategy management consultants,
6 accountants, technology consultants), sales and marketing (e.g., sales, marketing, advertising
7 and public relations, customer service), human resources (e.g., human resource management,
8 benefits, compensation, and training), finance (e.g., CFOs, commercial banking, and
investment banking), and materials management (e.g., inventory and quality control).

1 342. The method of claim 318 including:

2 selecting a plurality of items from said list as being responsive to said request,
3 providing said plurality of bids to said purchaser, and
4 conducting a reciprocally active bidding negotiation between said purchaser and said
5 plurality of sellers.

1 343. The method of claim 342 wherein:

2 said bidding negotiation is accessible to said purchaser and to each of said plurality of
3 sellers.

1 344. The method of claim 318 including:

2 receiving from each of said plurality of purchasers a request to receive bids to sell said
3 one item,
4 providing a plurality of seller bids to each of said purchasers to sell said one item, and
5 conducting a reciprocally active bidding negotiation between each said purchaser and
6 said plurality of sellers providing bids to that said purchaser.

1 345. The method of claim 344 wherein:

2 said bidding negotiation between each said purchaser and said sellers providing bids to
3 that purchasers is accessible to said purchaser and to each of said plurality of sellers, and

4 said bidding negotiations being participated in by any one purchaser accessible to any
5 other of said plurality of purchasers, contingent upon each of said purchasers granting access
6 to that purchaser's negotiations.

1 346. The method of claim 318 wherein:
2 said bidding negotiation is conducted between said purchaser and a plurality of sellers.

1 347. The method of claim 346 including:
2 processing a reciprocal interactive bidding negotiation between said purchaser and a
3 plurality of vendors in response to a bid by each of said plurality of vendors, and
4 pausing said negotiations with all except one of said plurality of vendors while
5 continuing said negotiation with the remaining vendor.

1 348. The method of claim 318 wherein:
2 said index includes bundles, each said bundle selected from a group of individual
3 product items and individual service items.

1 349. A system for procurement using a computer that communicates over a network, the
2 system comprising:
3 a memory for maintaining a first list descriptions from each of a plurality of sellers of
4 an identified item for sale by said seller, each said item described by a set of item features, and
5 said memory for maintaining a second list of identified items in an index of individual product
6 items and individual service items;
7 one or more network interfaces adapted to send and receive data to and from
8 customer nodes and vendor nodes; and
9 one or more processors in communication with the memory,
10 wherein, when the one or more network interfaces receives a request from one of a
11 plurality of customer nodes to receive bids to sell one of said individual product and service
12 items, the request including a set of item attributes desired in said item, the one or more
13 processors compare said item attributes with said item features for responsiveness to said
14 request, select at least one selected item from said list as being responsive to said request, and
15 submit that item to that customer node in the form of an offer to sell the selected item, and

16 the one or more processors process a reciprocally active bidding negotiation between
17 said purchaser and said seller.

1 350. The system of claim 349 wherein:

2 the bidding negotiation is conducted between the purchaser and a plurality of sellers,
3 and the bidding negotiation is accessible to the purchaser and to each of the plurality of
4 sellers.

1 351. A computer program product comprising a machine readable medium on which is

2 provided program instructions for performing a method for procurement using a
3 computer that communicates over a network, the program instructions comprising:
4 program code for receiving from each of a plurality of sellers an identification of an
5 identified item for sale by said seller, each said item identified by a set of item features,
6 program code for maintaining a list of said identified items in an index of individual
7 product items and individual service items,

8 program code for receiving from one of a plurality of purchasers a request to receive
9 bids to sell one of said individual product and service items, said request including a set of
10 item attributes desired in said item,

11 program code for comparing said item attributes with said item features for
12 responsiveness to said request,

13 program code for selecting at least one selected item from said list as being responsive
14 to said request,

15 program code for providing at least one bid to said purchaser, said bid to sell said
16 selected item, and

17 program code for conducting a reciprocally active bidding negotiation between said
18 purchaser and said seller.

1 352. The computer program product of claim 351 wherein:

2 said bidding negotiation is conducted between said purchaser and a plurality of sellers,
3 and said bidding negotiation is accessible to said purchaser and to each of said plurality of
sellers.

- 1 353. The method of claim 352 wherein:
2 said bidding negotiation is accessible to said purchaser and to each of said plurality of
3 sellers.
- 1 354. The method of claim 318 including:
2 facilitating said negotiation by providing direct communication between said purchaser
3 and any one of said plurality of sellers for negotiations between said purchaser and said any
4 one seller.
- 1 355. The method of claim 13 including:
2 said negotiation including revisions to terms, said terms comprising price, item
3 features, and item quality.
- 1 356. The method of claim 355 wherein:
2 said terms comprise method of payment, quality of customer service, and credit terms.
- 1 357. The method of claim 1 including:
2 sending to said plurality of vendors accountability information about said purchaser,
3 said accountability information comprising a number of experiences the customer has had with
4 the system, a number of experiences that resulted in successful transactions, a number of
5 experiences that resulted in unsuccessful transactions, and vendor feedback.
- 1 358. The method of claim 62 including:
2 sending to said plurality of vendors accountability information about said purchaser,
3 said accountability information comprising a number of experiences the customer has had with
4 the system, a number of experiences the customer has had with the system that resulted in
5 successful transactions, a number of experiences the customer has had with the system that
6 resulted in unsuccessful transactions, and vendor feedback.
- 1 359. The method of claim 151 including:
2 sending to said plurality of vendors accountability information about said purchaser,

3 said accountability information comprising a number of experiences the customer has had with
4 the system, a number of experiences the customer has had with the system that resulted in
5 successful transactions, a number of experiences the customer has had with the system that
6 resulted in unsuccessful transactions, and vendor feedback.

1 360. The method of claim 198 including:

2 sending to said plurality of vendors accountability information about said purchaser,
3 said accountability information comprising a number of experiences the customer has had with
4 the system, a number of experiences the customer has had with the system that resulted in
5 successful transactions, a number of experiences the customer has had with the system that
6 resulted in unsuccessful transactions, and vendor feedback.

1 361. The method of claim 242 including:

2 sending to said plurality of vendors accountability information about said purchaser,
3 said accountability information comprising a number of experiences the customer has had with
4 the system, a number of experiences the customer has had with the system that resulted in
5 successful transactions, a number of experiences the customer has had with the system that
6 resulted in unsuccessful transactions, and vendor feedback.

1 362. The method of claim 265 including:

2 sending to said plurality of vendors accountability information about said purchaser,
3 said accountability information comprising a number of experiences the customer has had with
4 the system, a number of experiences the customer has had with the system that resulted in
5 successful transactions, a number of experiences the customer has had with the system that
6 resulted in unsuccessful transactions, and vendor feedback.

1 363. The method of claim 268 including:

2 sending to said plurality of vendors accountability information about said purchaser,
3 said accountability information comprising a number of experiences the customer has had with
4 the system, a number of experiences the customer has had with the system that resulted in
5 successful transactions, a number of experiences the customer has had with the system that
6 resulted in unsuccessful transactions, and vendor feedback.

1 364. The method of claim 268 including:
2 sending to purchasers accountability information about each of said plurality of sellers,
3 said accountability information comprising a number of experiences each said seller has had
4 with the system, a number of experiences said seller has had with the system that resulted in
5 successful transactions, a number of experiences said seller has had with the system that
6 resulted in unsuccessful transactions, and purchaser feedback.

FIGURES

Figure – 1: Simple Catalogue Shopping

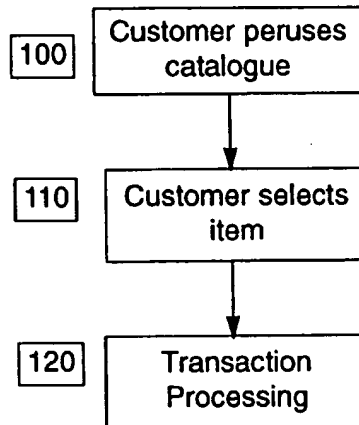
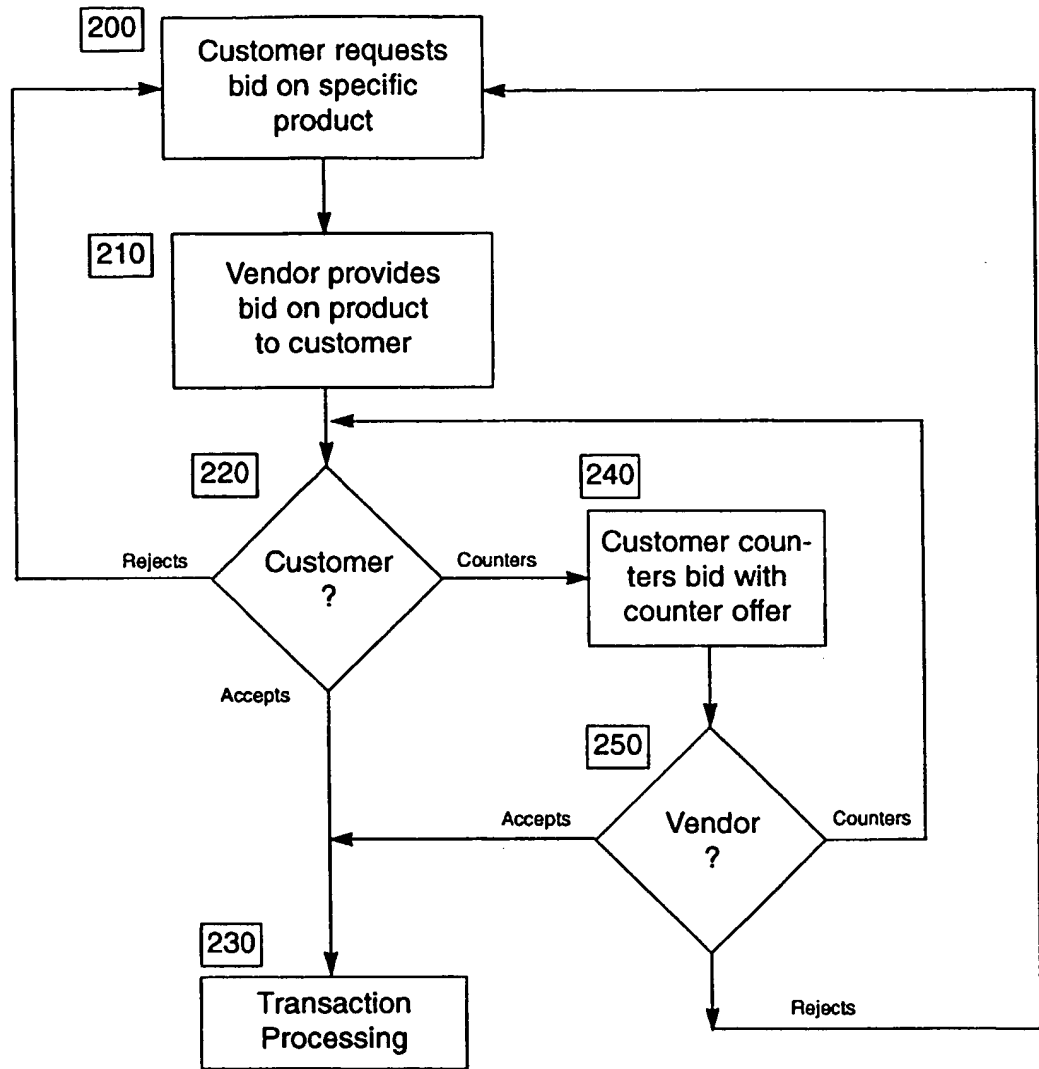

Figure – 2: Simple Reverse Auction



Figur – 3: Simple Conditional Purchase Offer (CPO)

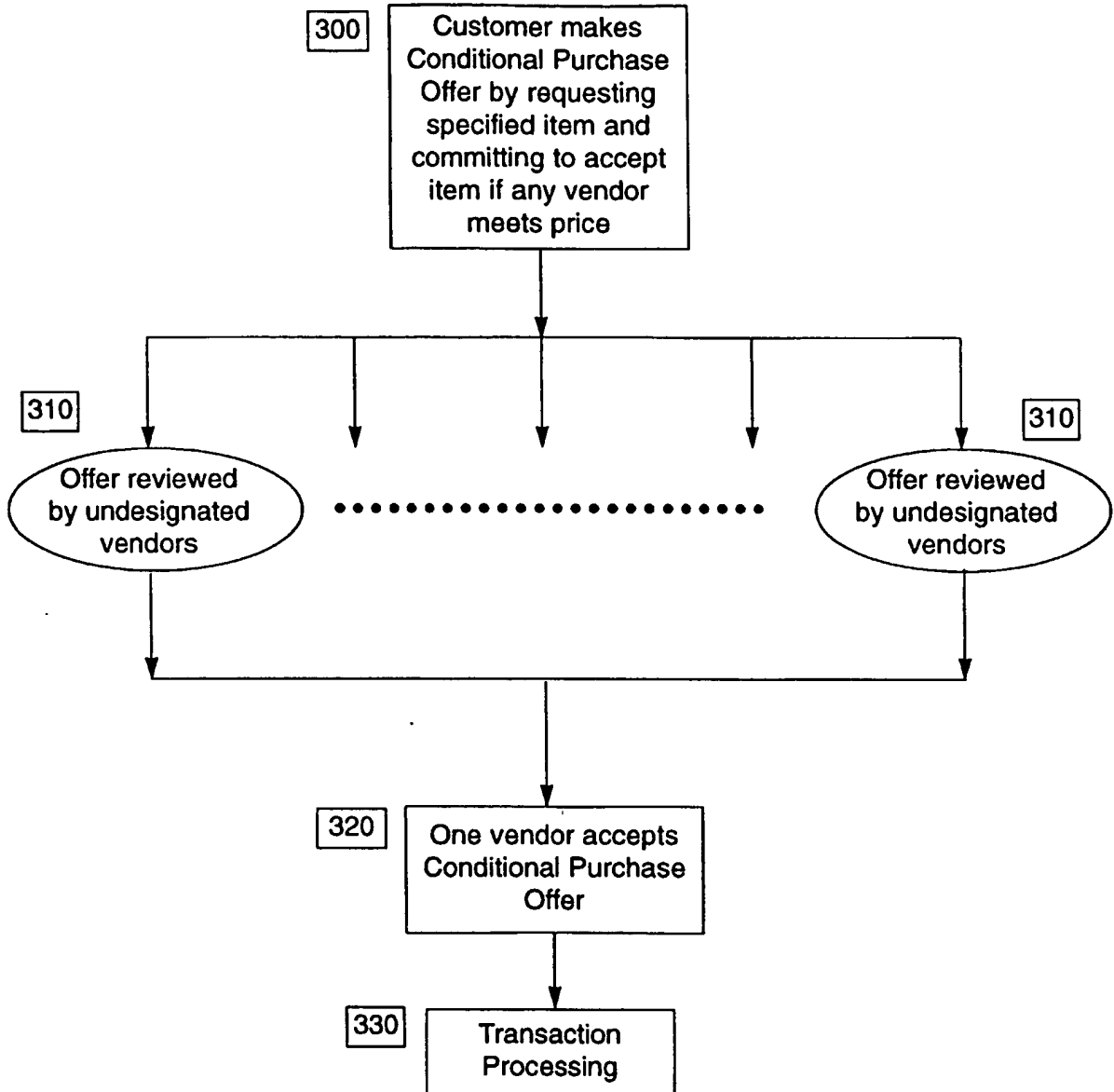

Figure – 4: Simple Request For Quote (RFQ)

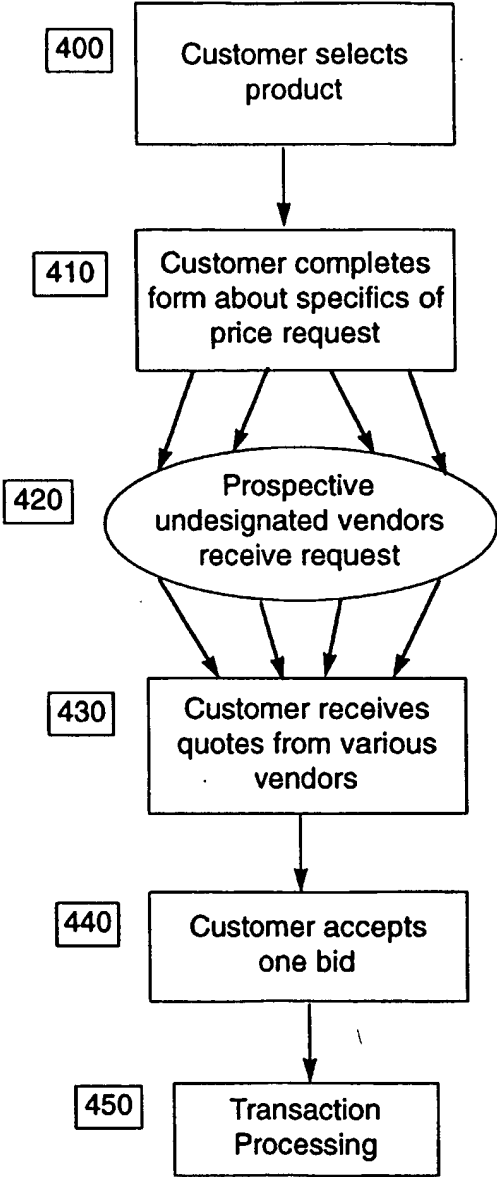
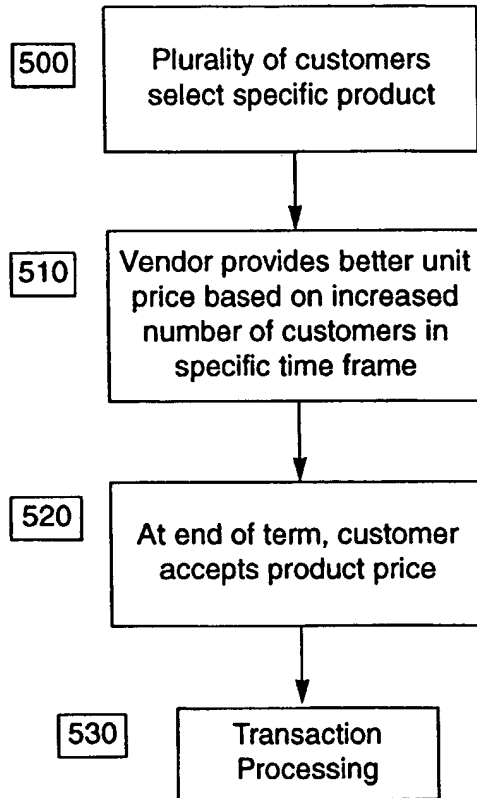

Figure – 5: Simpl Aggr gation



Figur - 6: Option Contracts

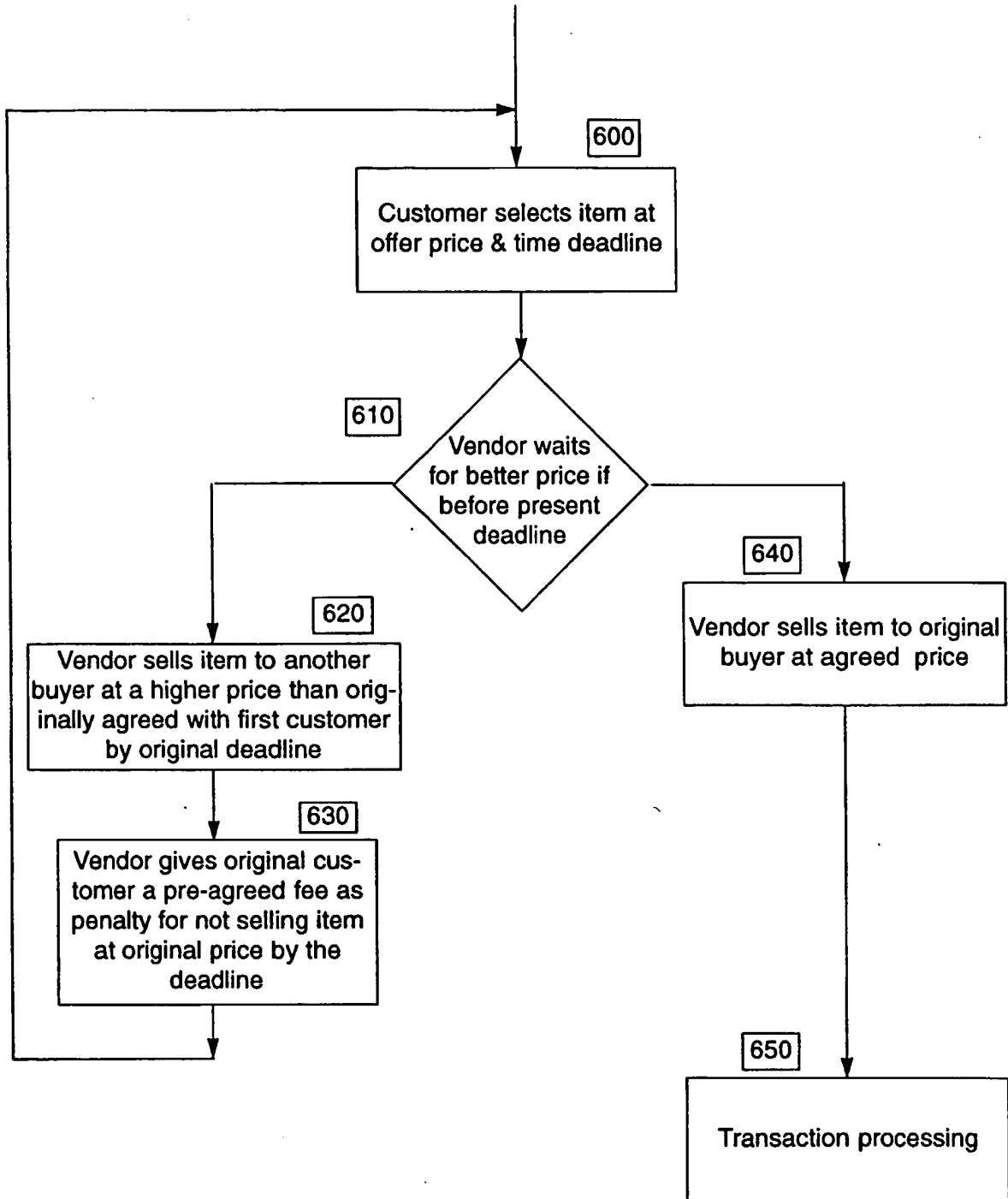

Figure - 7: System Overview

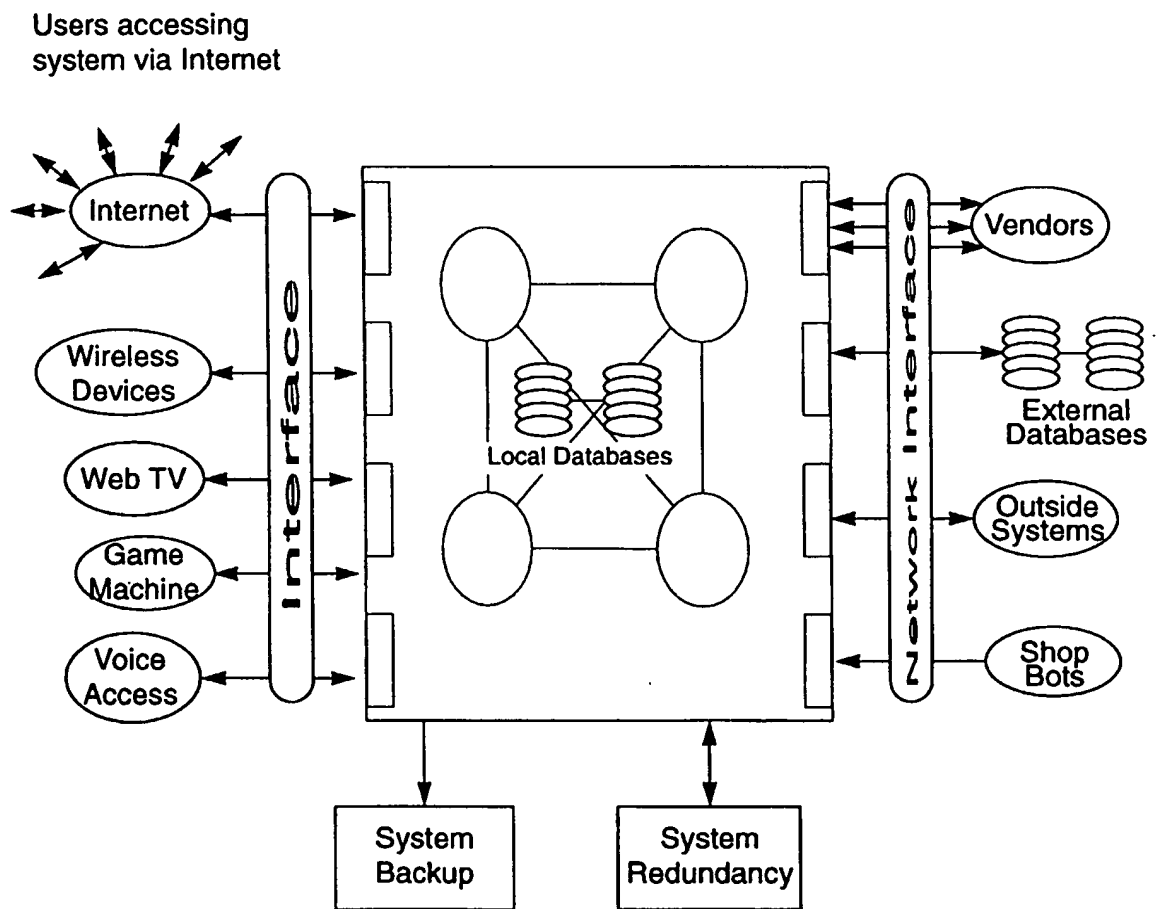

Figure - 8: System Abstract

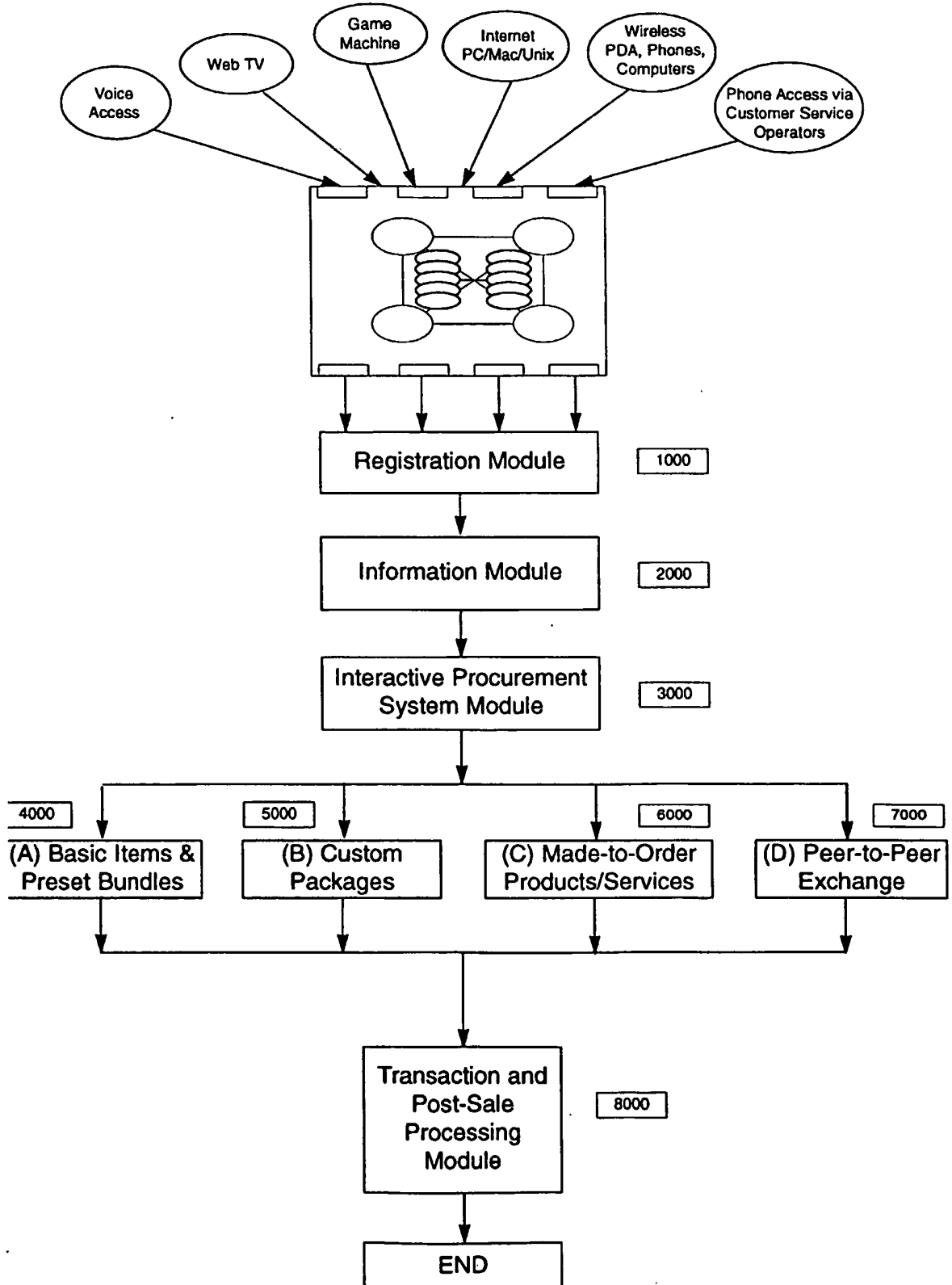

Figure - 9a: Registration Modul (1000)

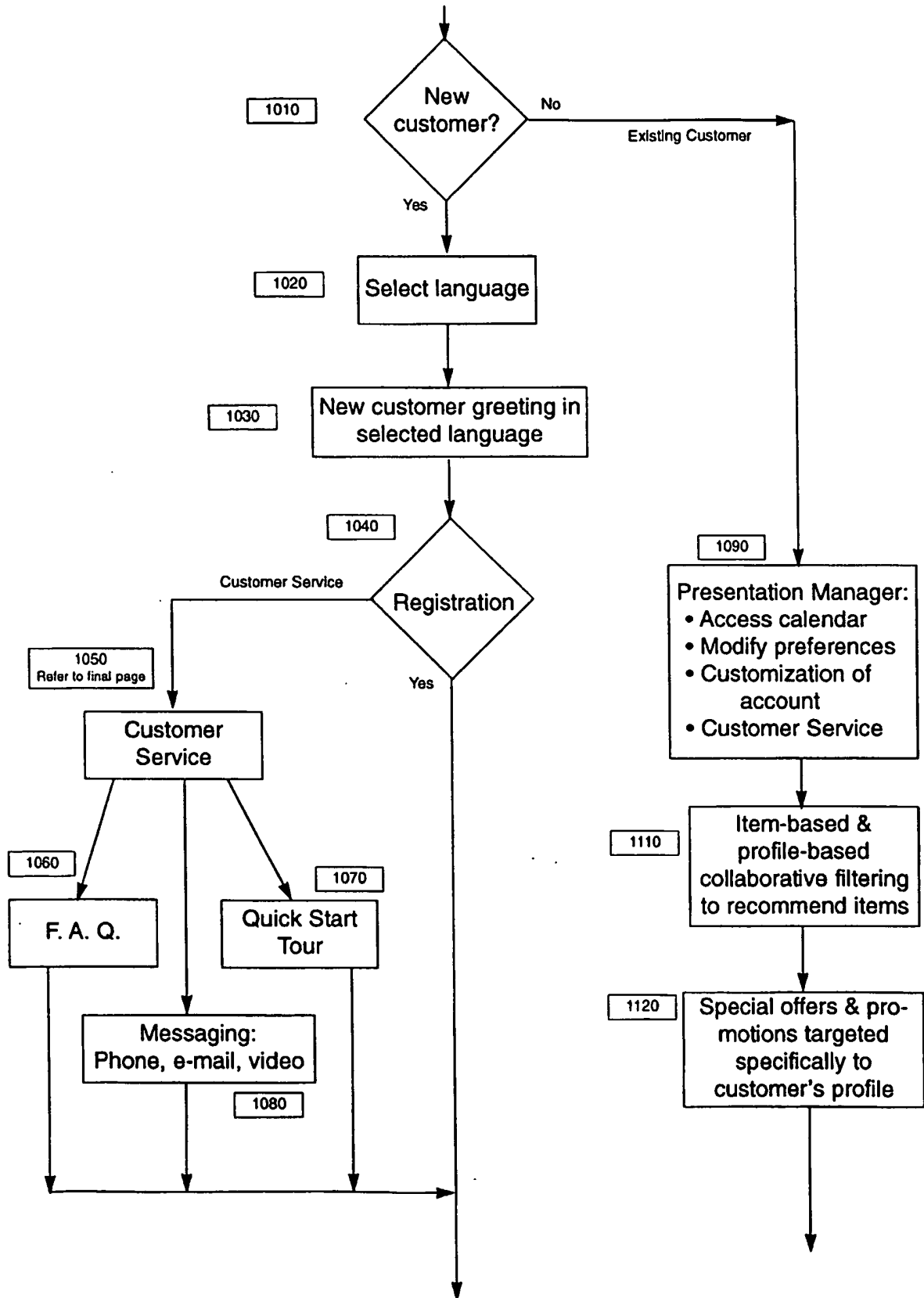

Fig. 9b

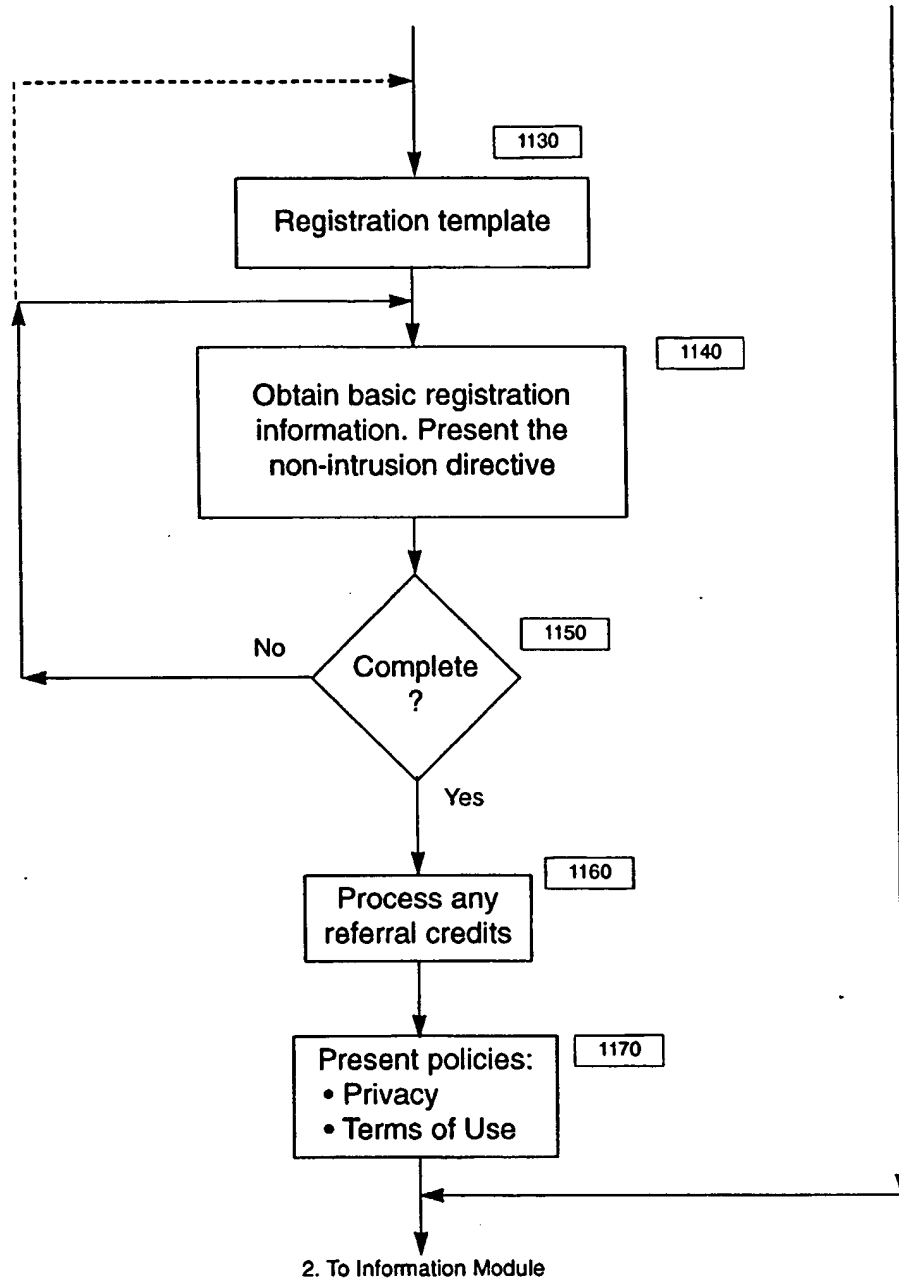

Figure - 10a: Information Module (2000)

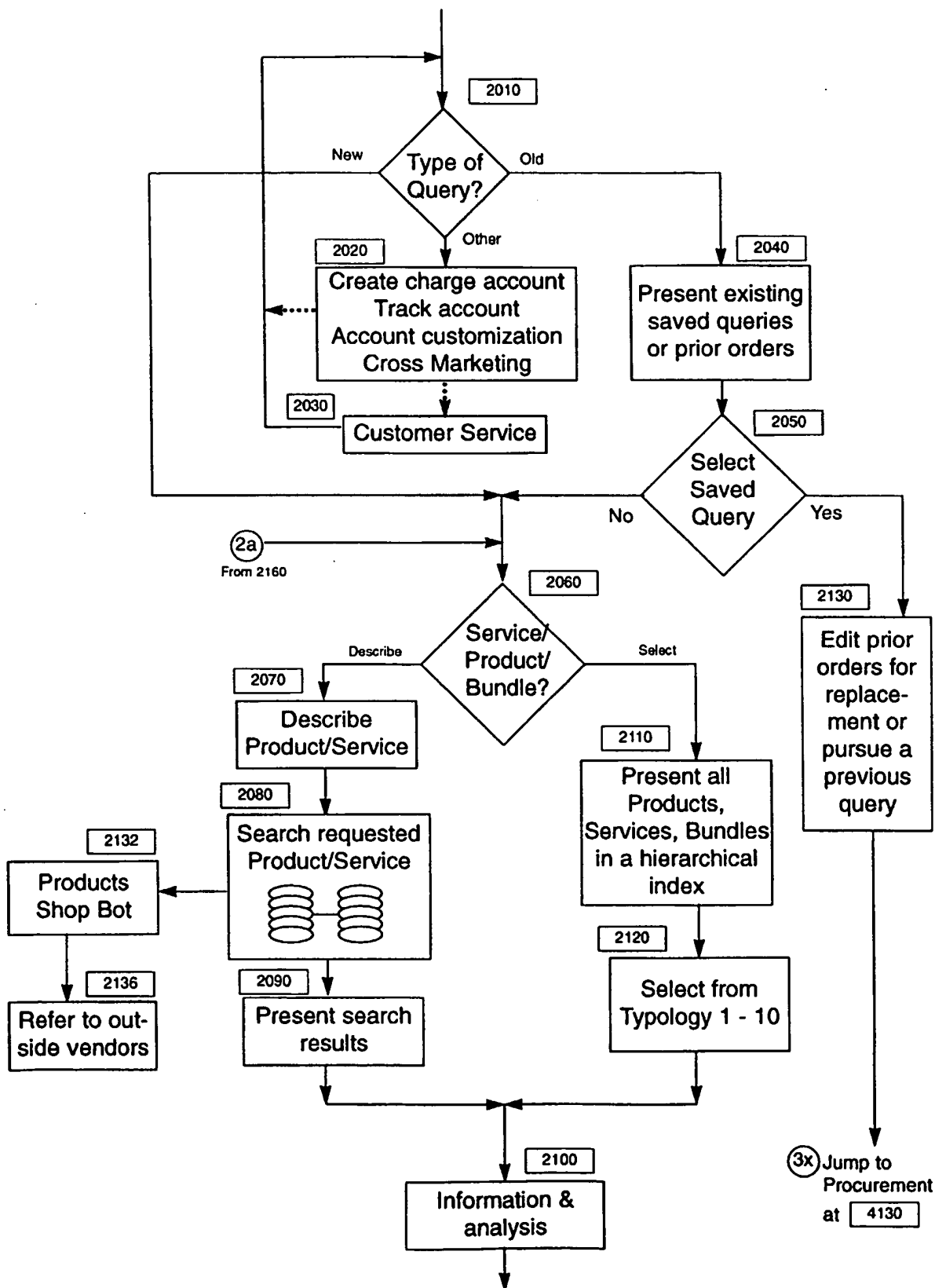

Fig. 10b

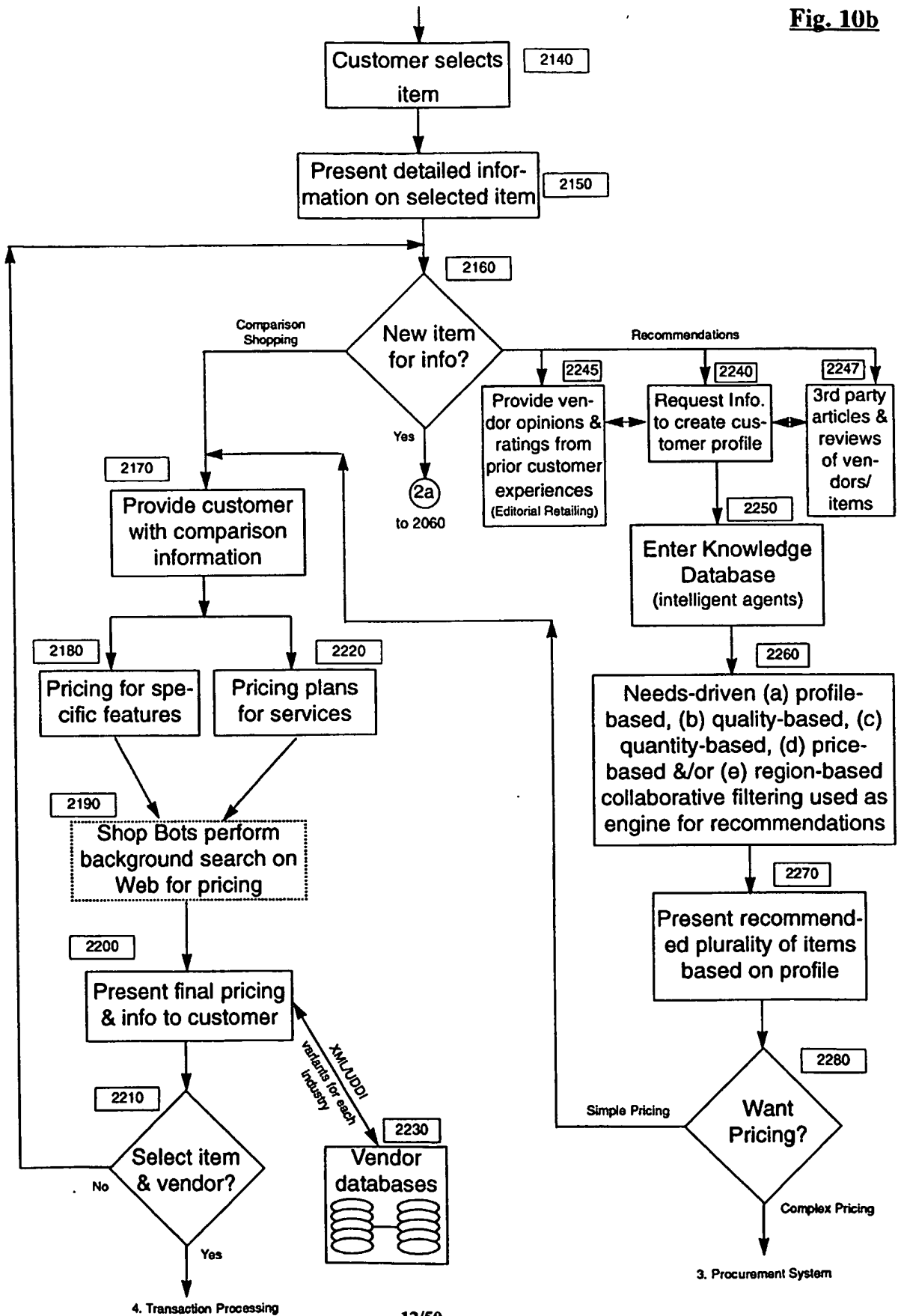

Figure - 11a: Typology 1 – 11: Product/Services/Bundles

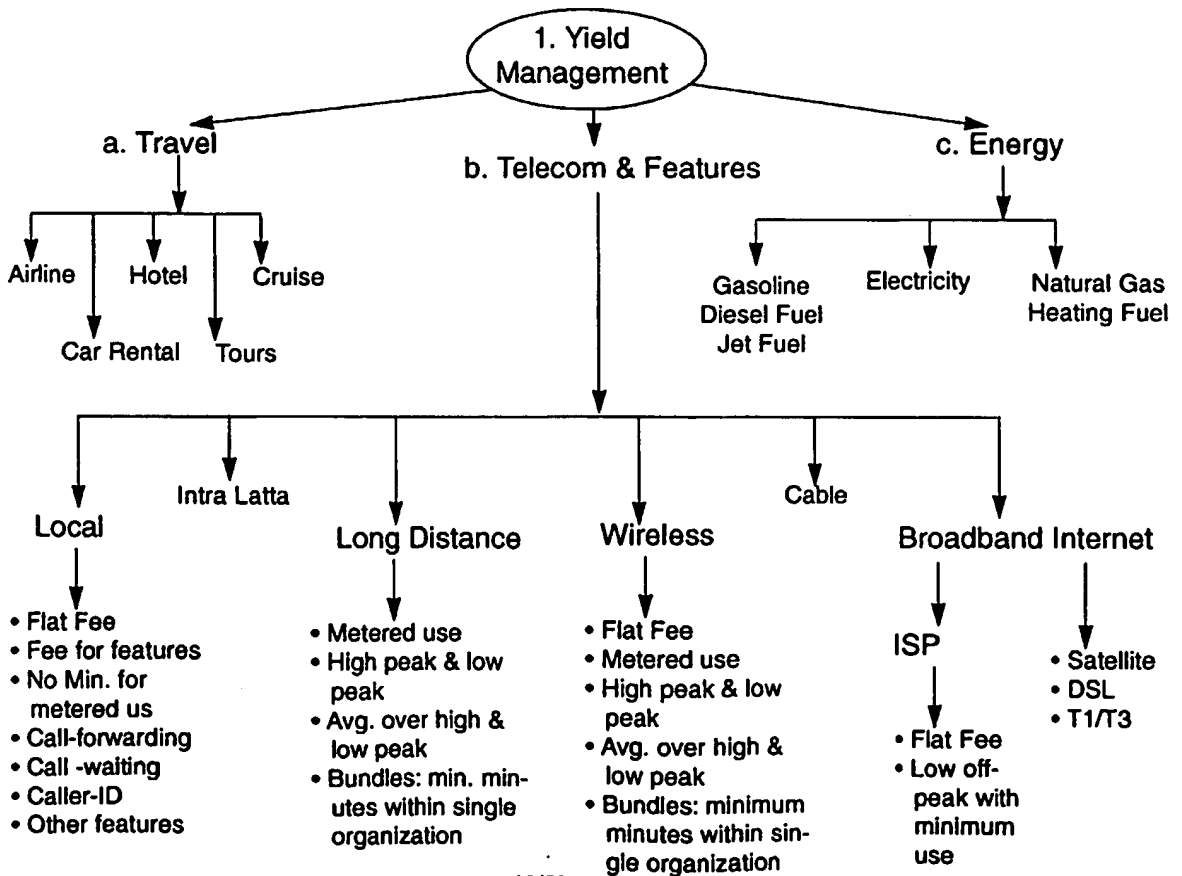
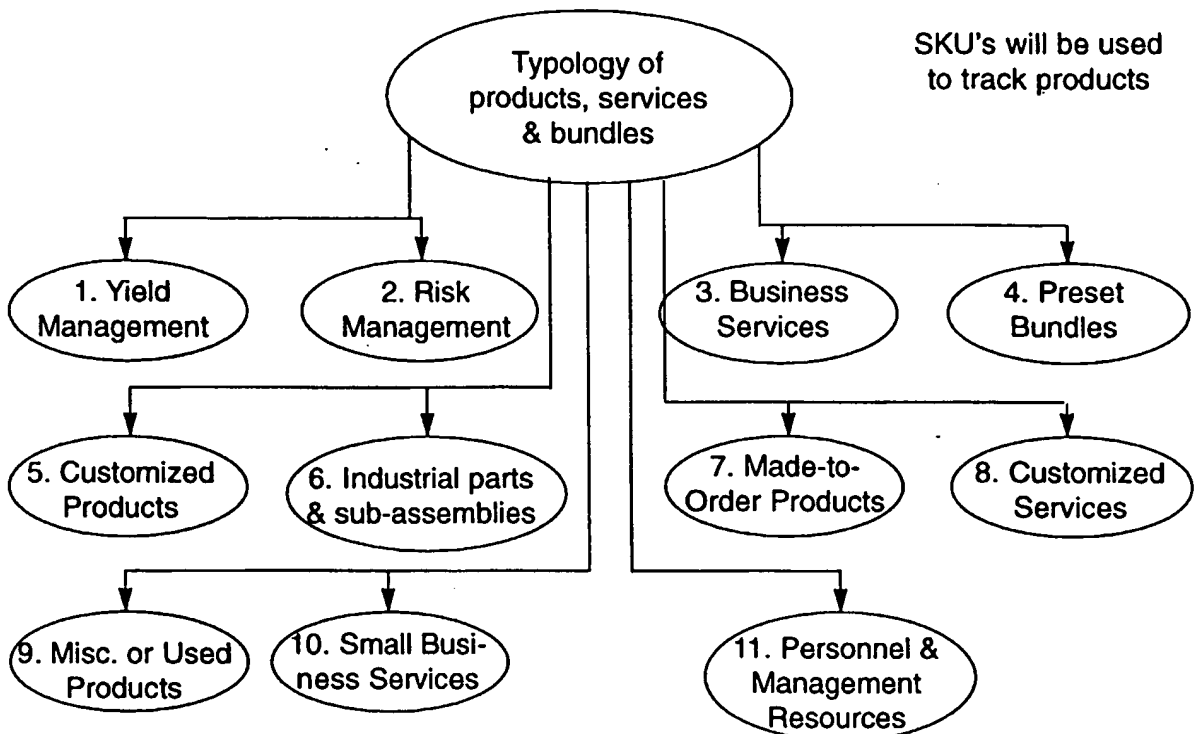

Fig. 11b

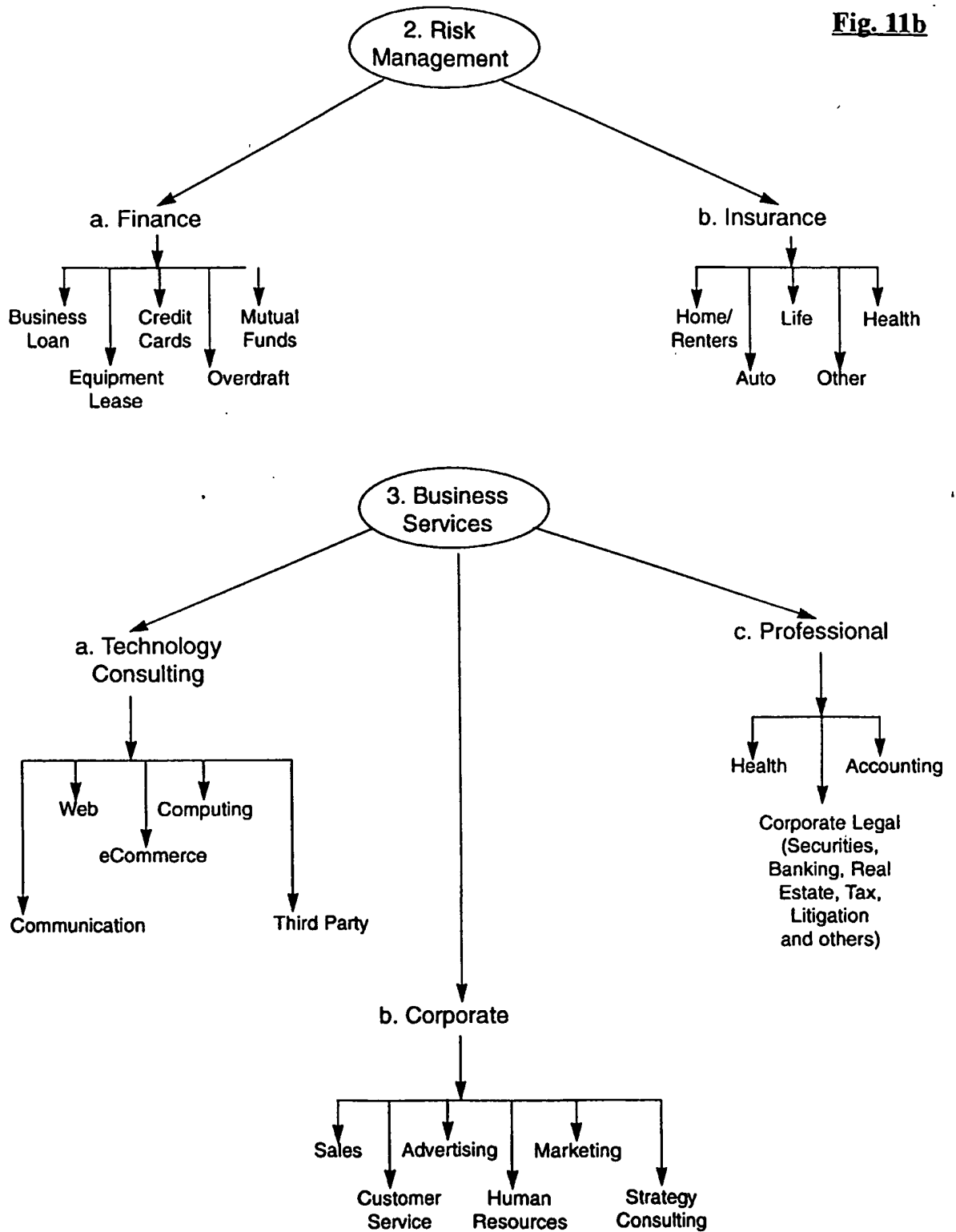

Fig. 11c

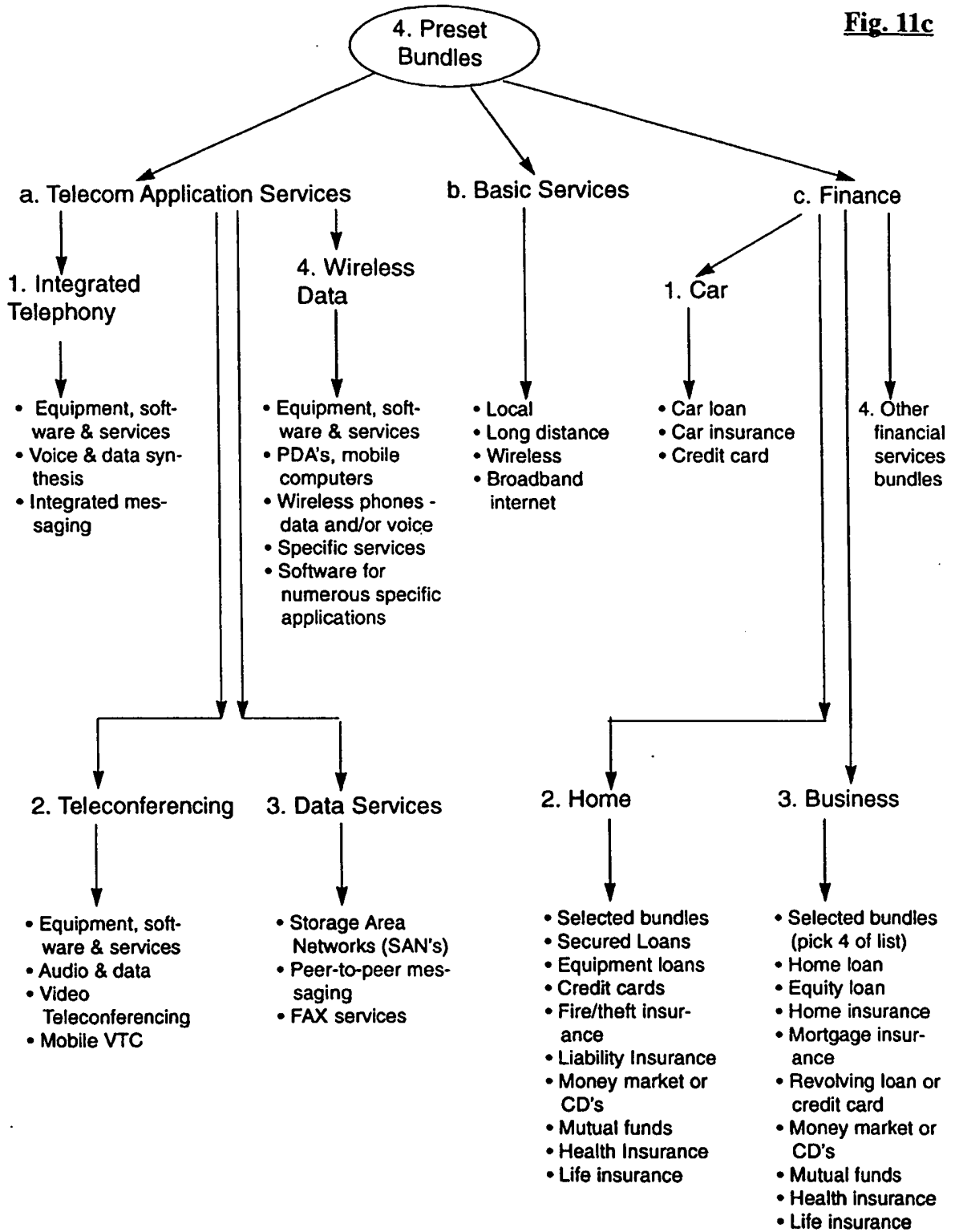

Fig. 11d

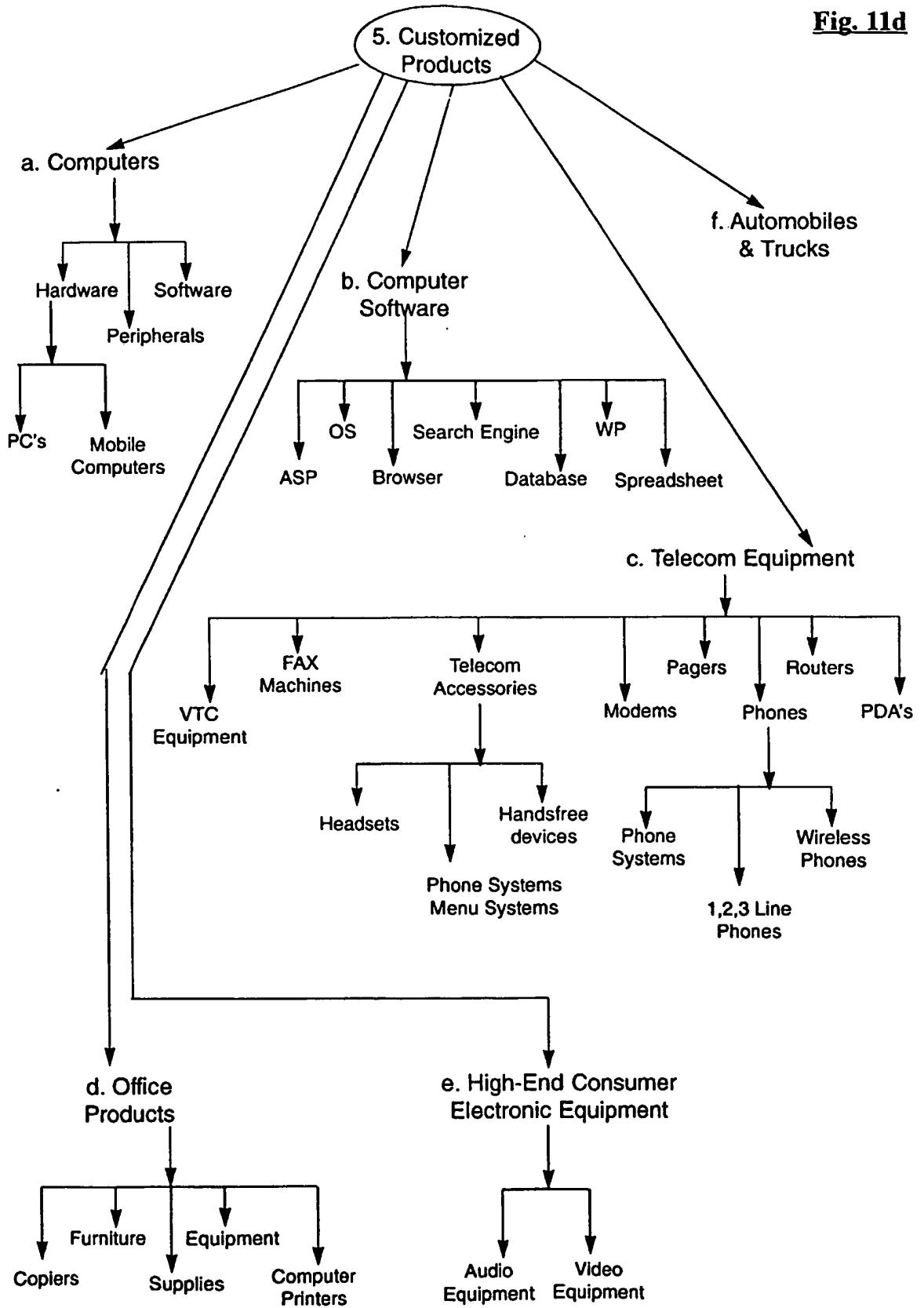

Fig. 11e

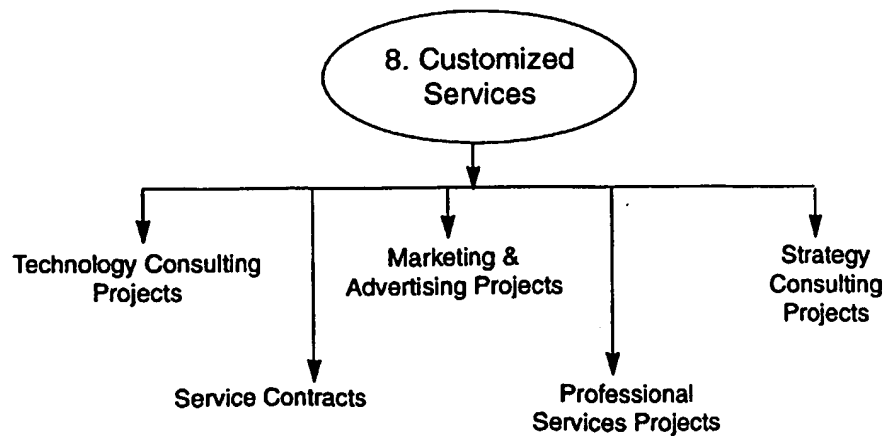
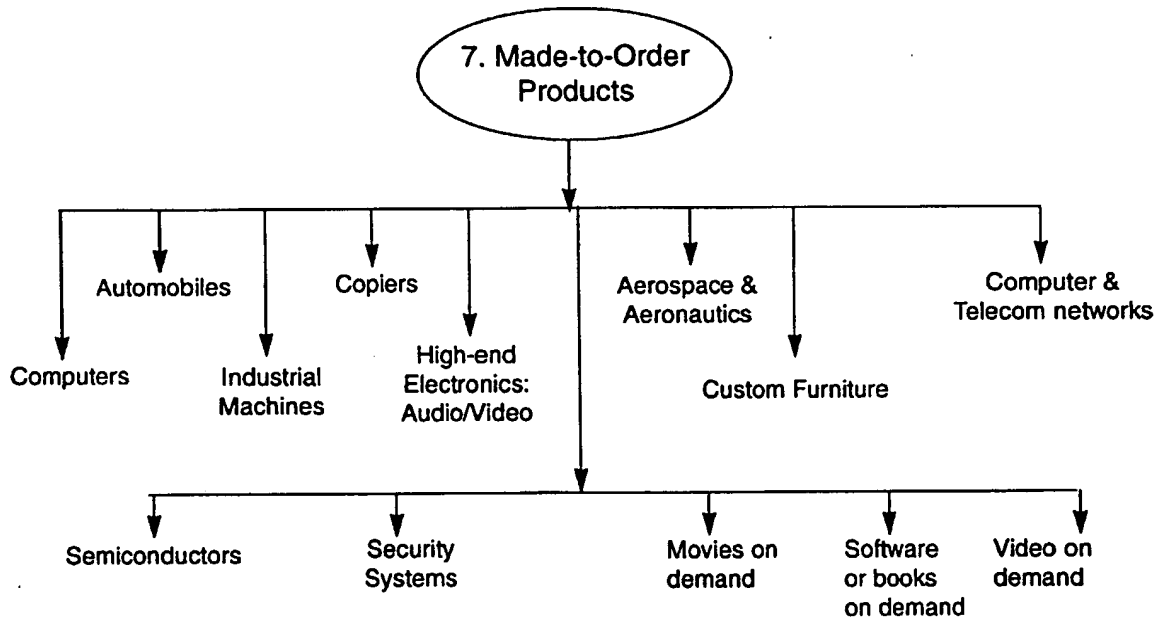
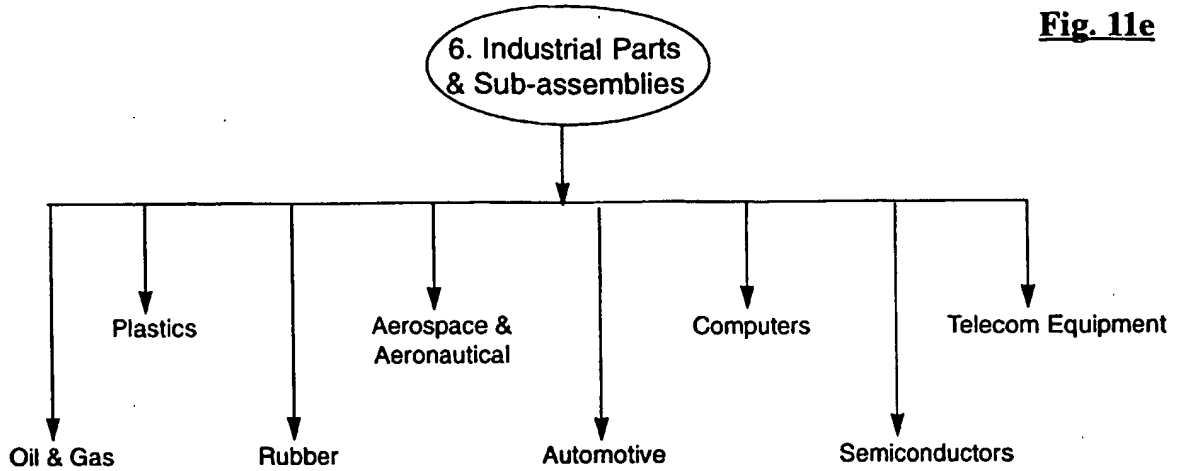

Fig. 11f

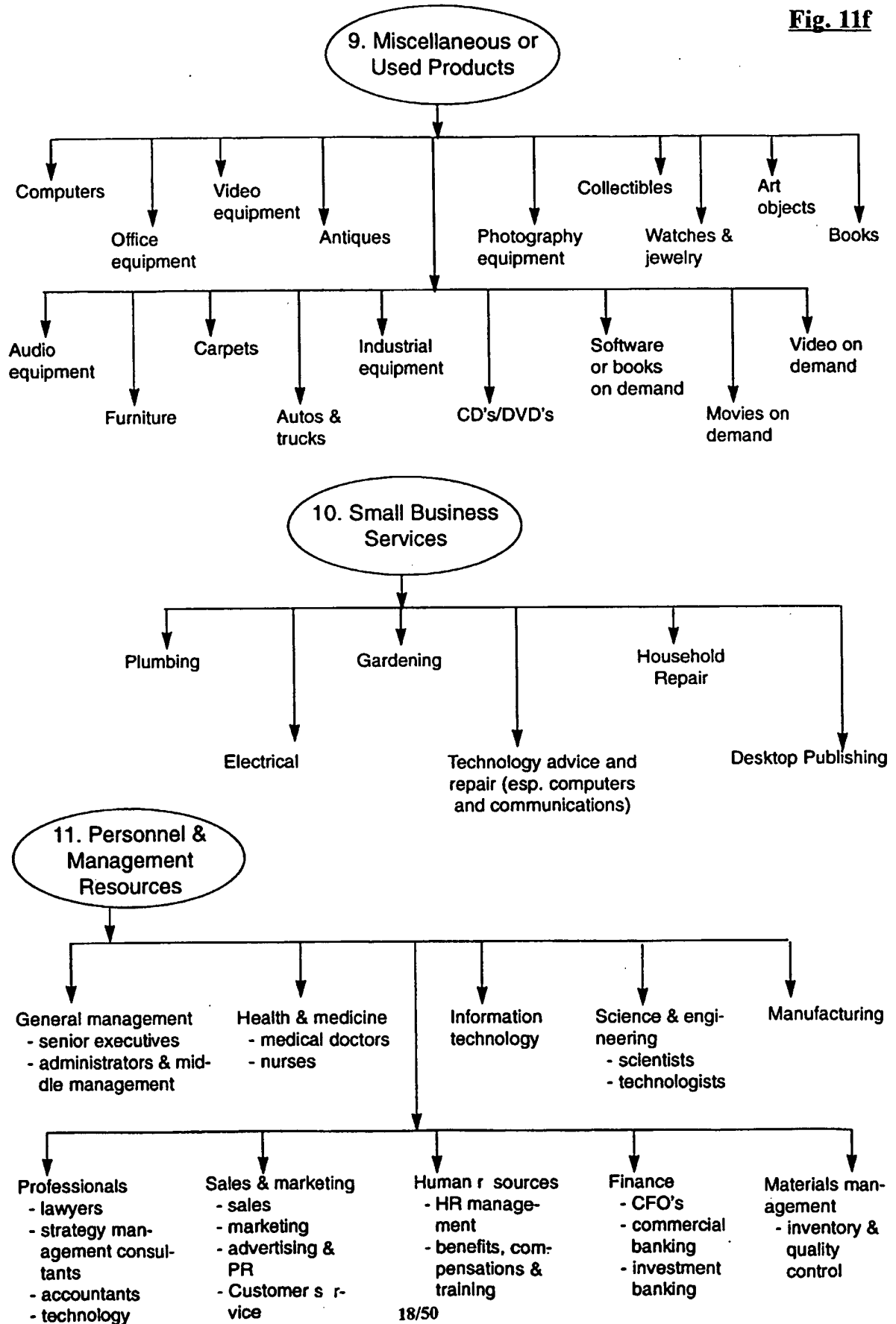

Figure - 12: Interactive Procurement Module (3000)

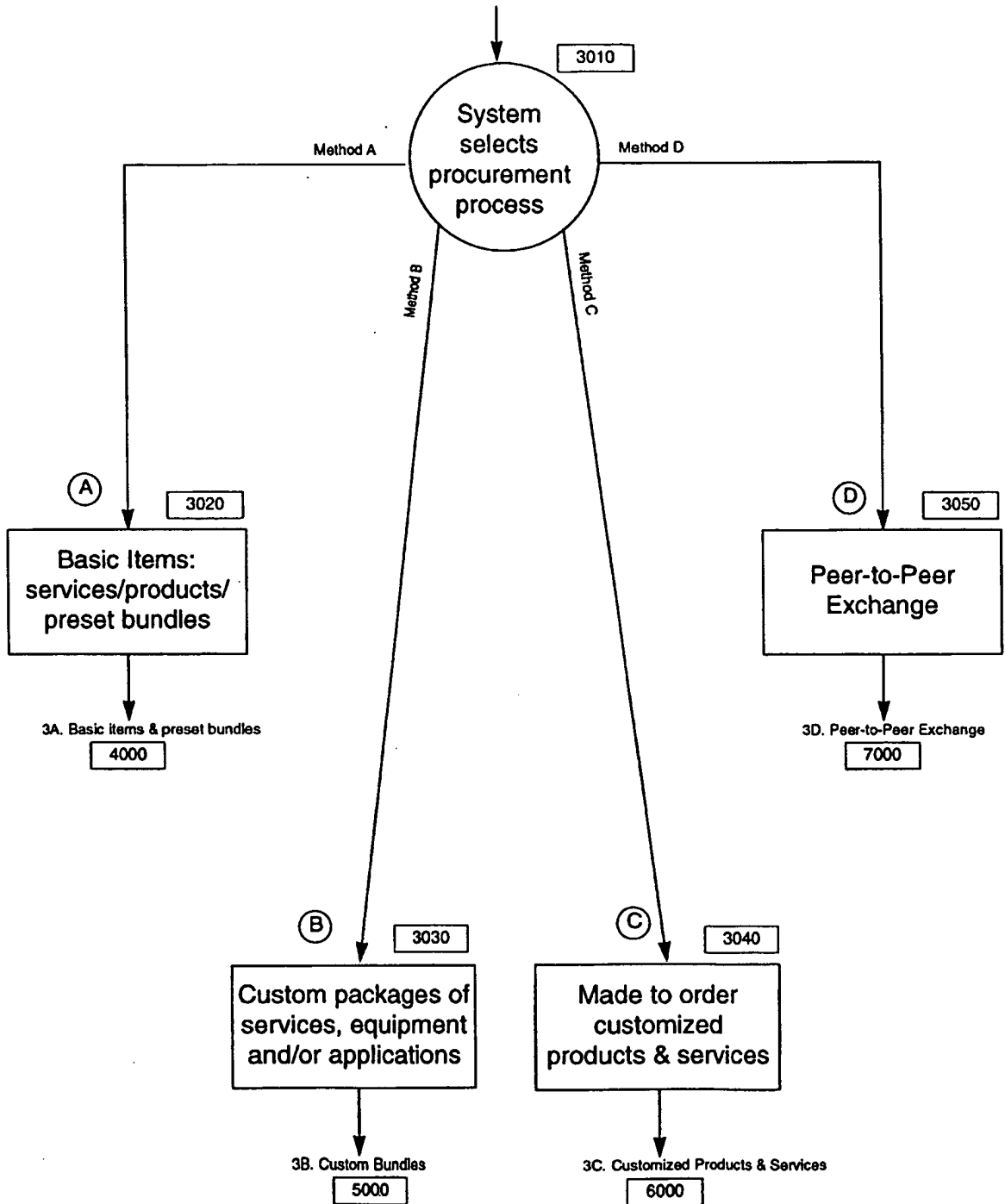

Figure - 13a: 3A. Procurement – Basic Items & Preset Bundl s (4000)

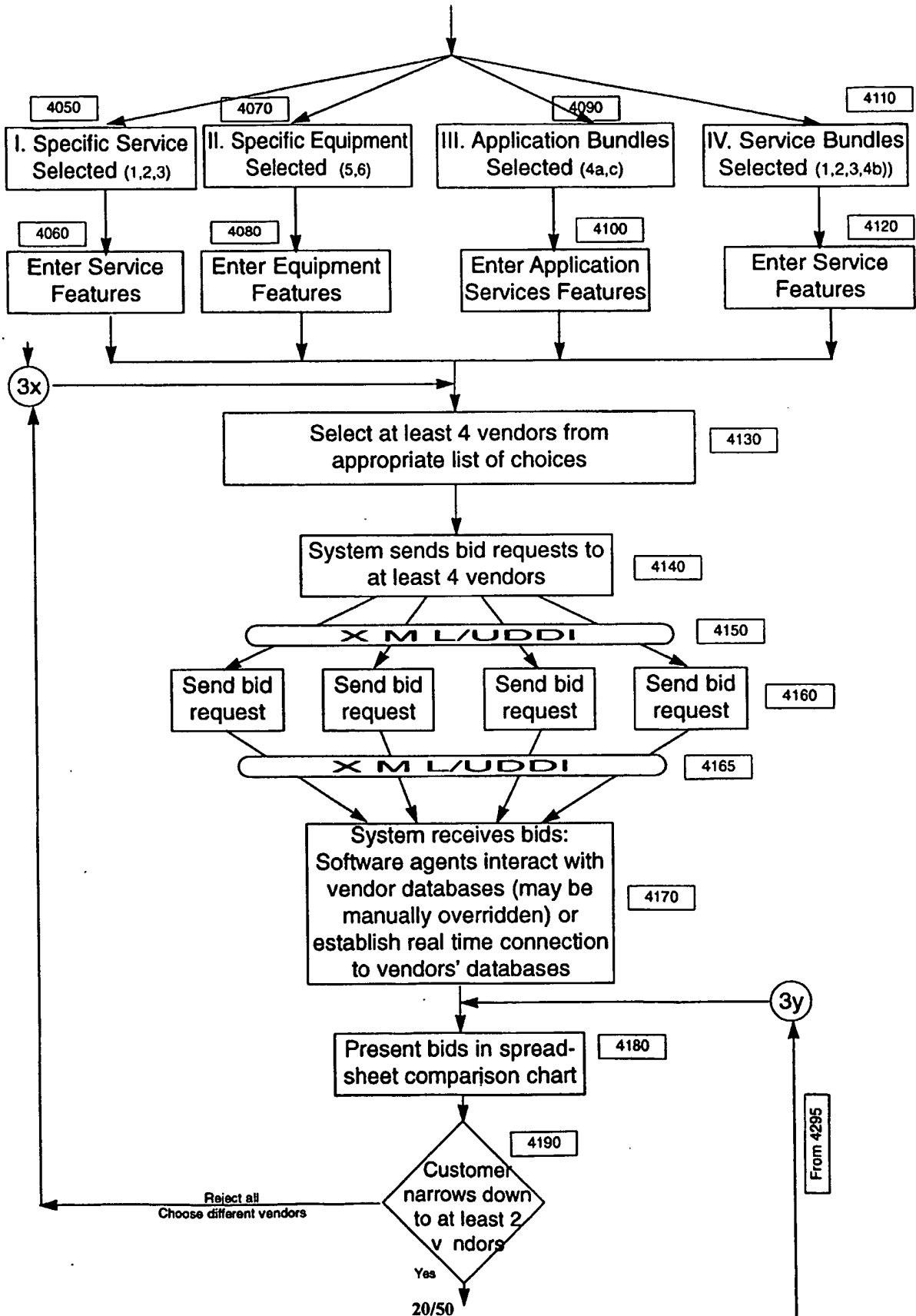
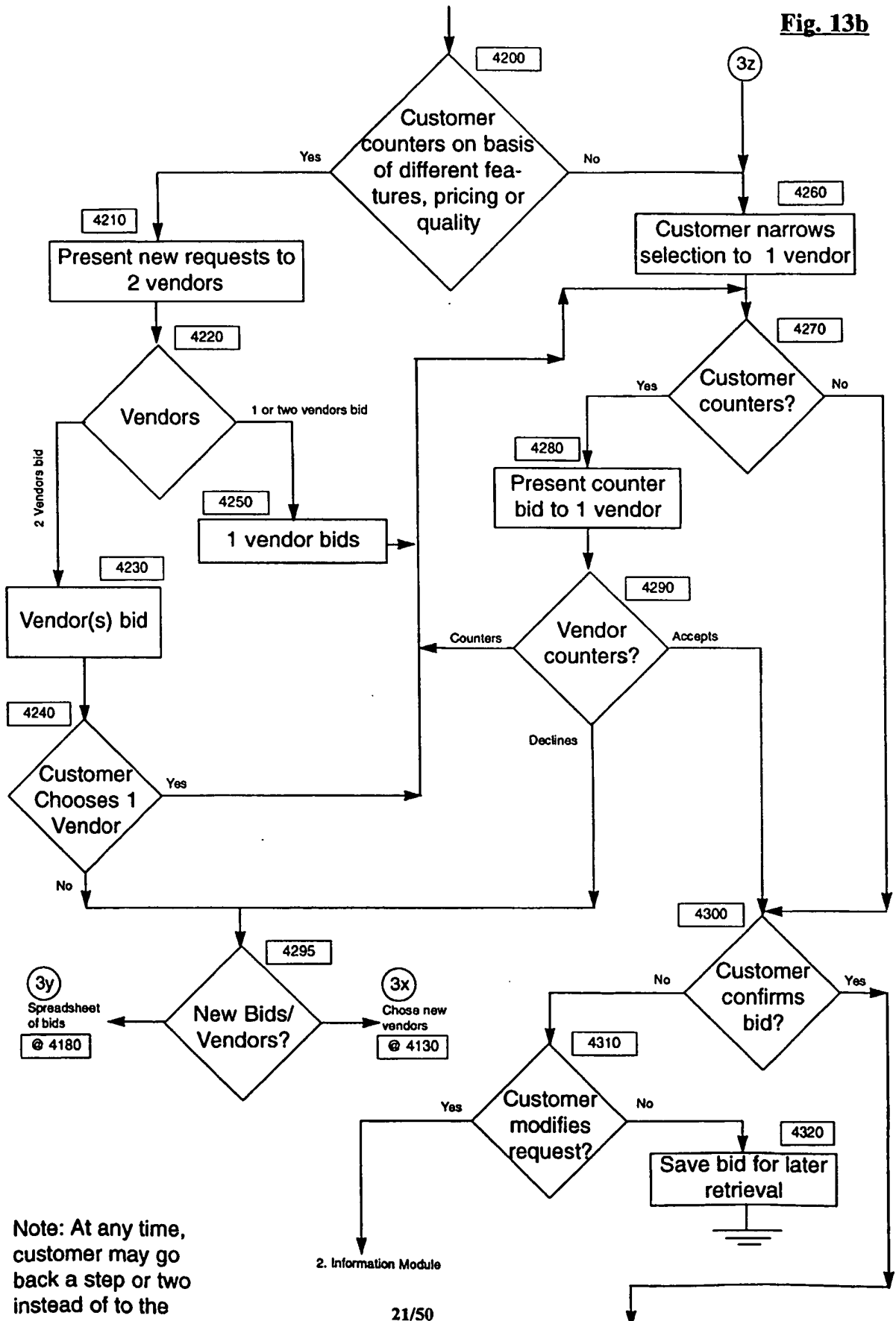

Fig. 13b



Note: At any time, customer may go back a step or two instead of to the

2. Information Module

Figure - 14a: 3B. Procurement – Custom Packages (5000)

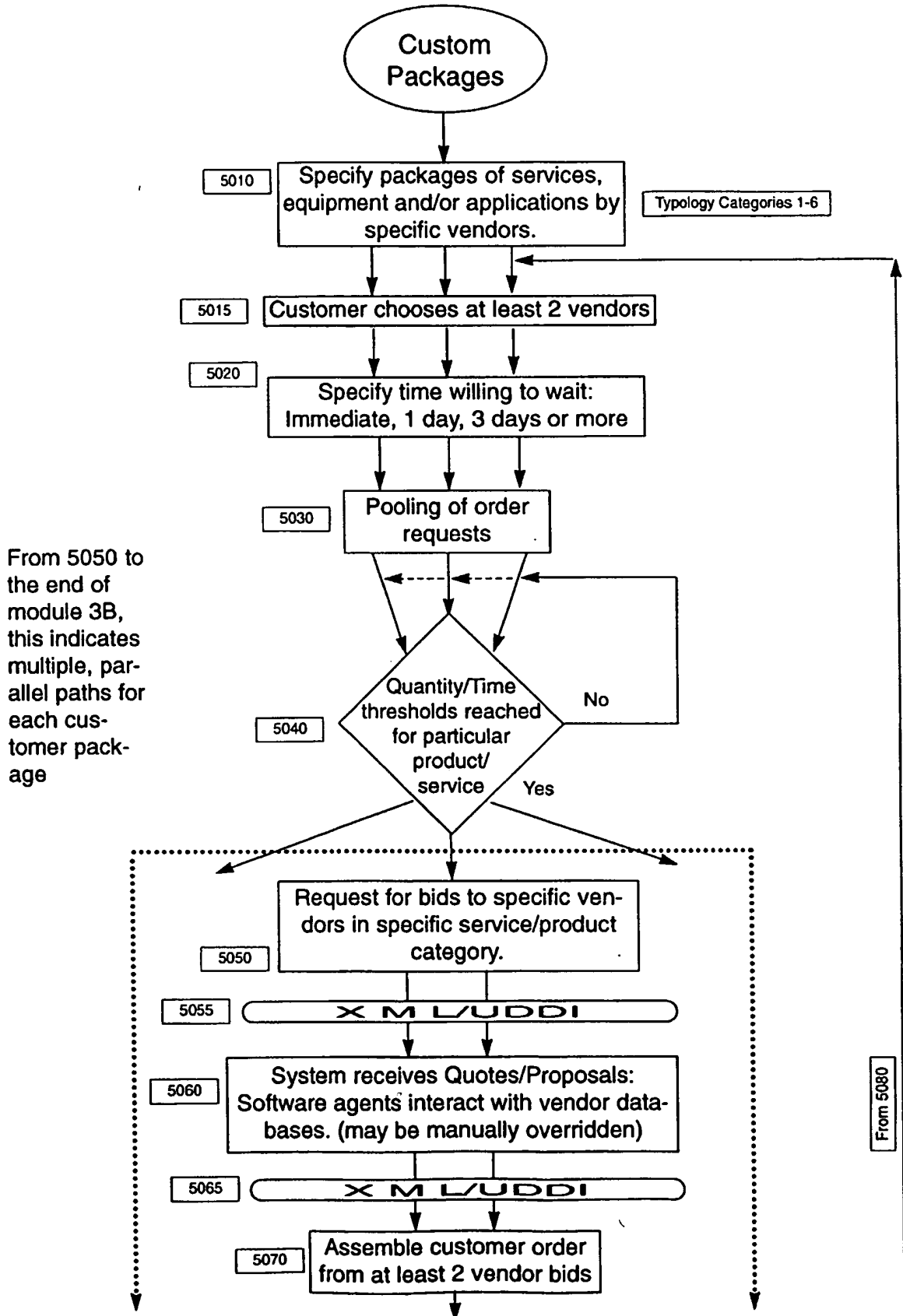

From 5050 to the end of module 3B, this indicates multiple, parallel paths for each customer package

From 5080

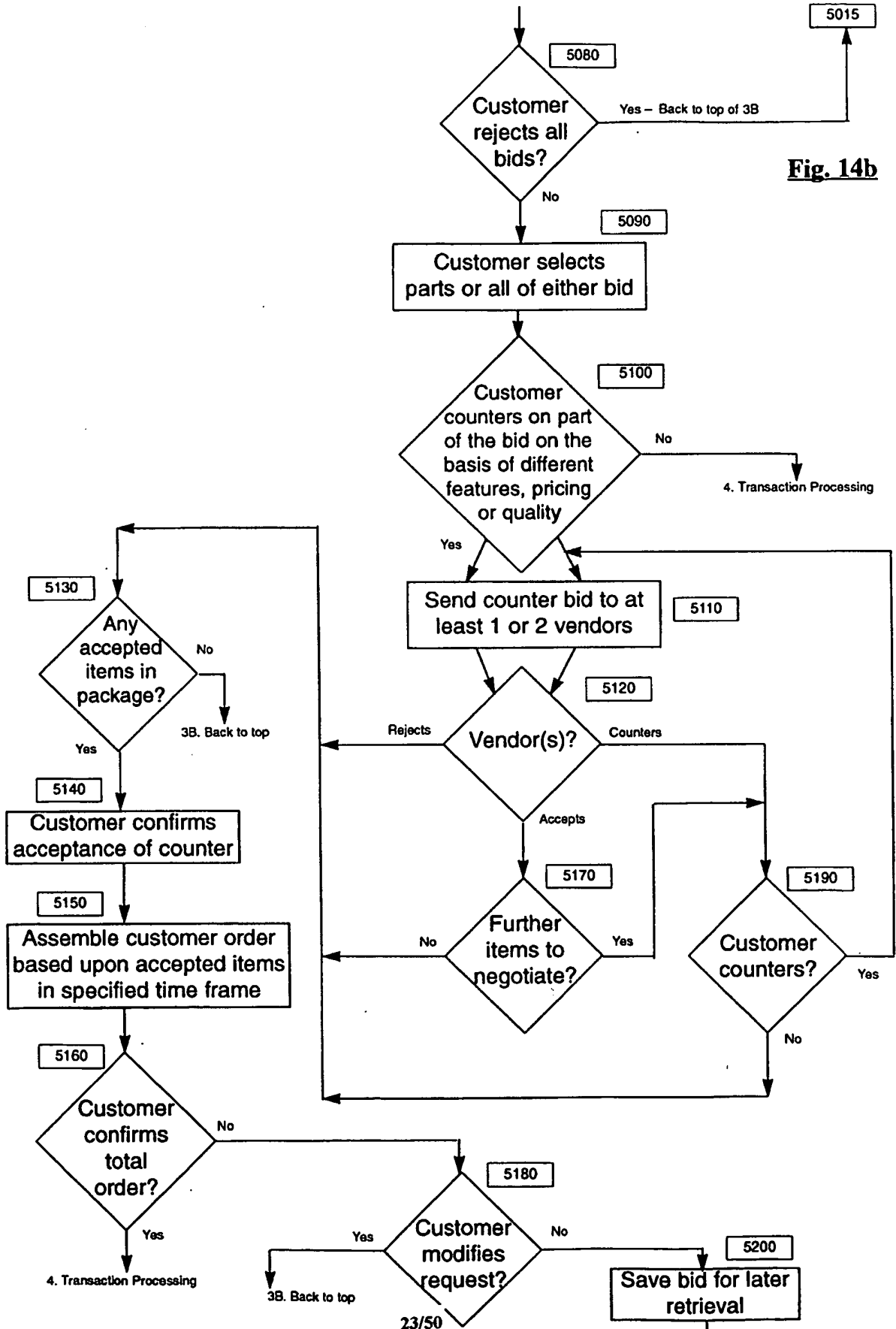

Fig. 14b

**Figure - 15a: 3C. Procurement (6000)
Made-to-Order Customized Products and Services**

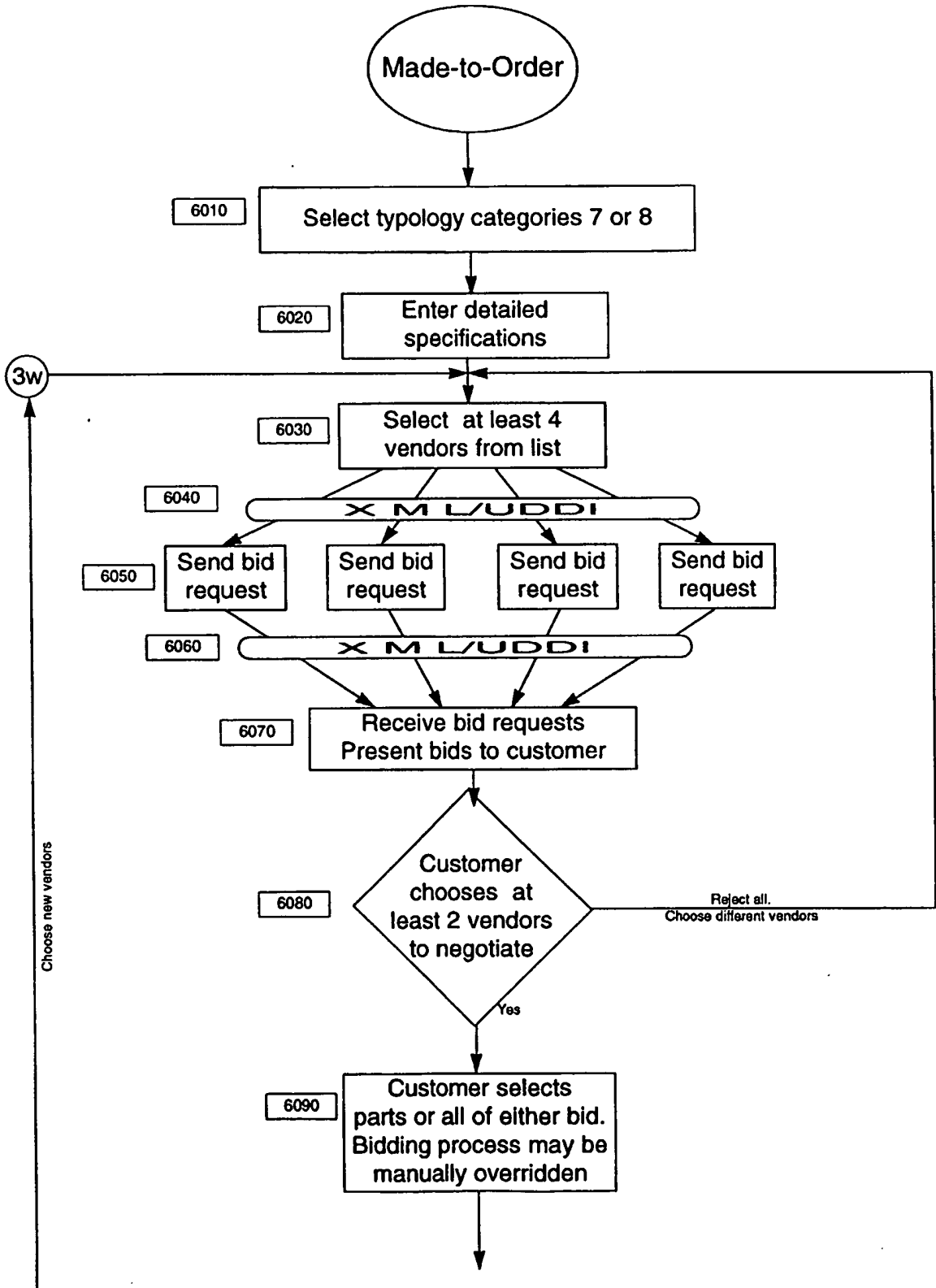

Fig. 15b

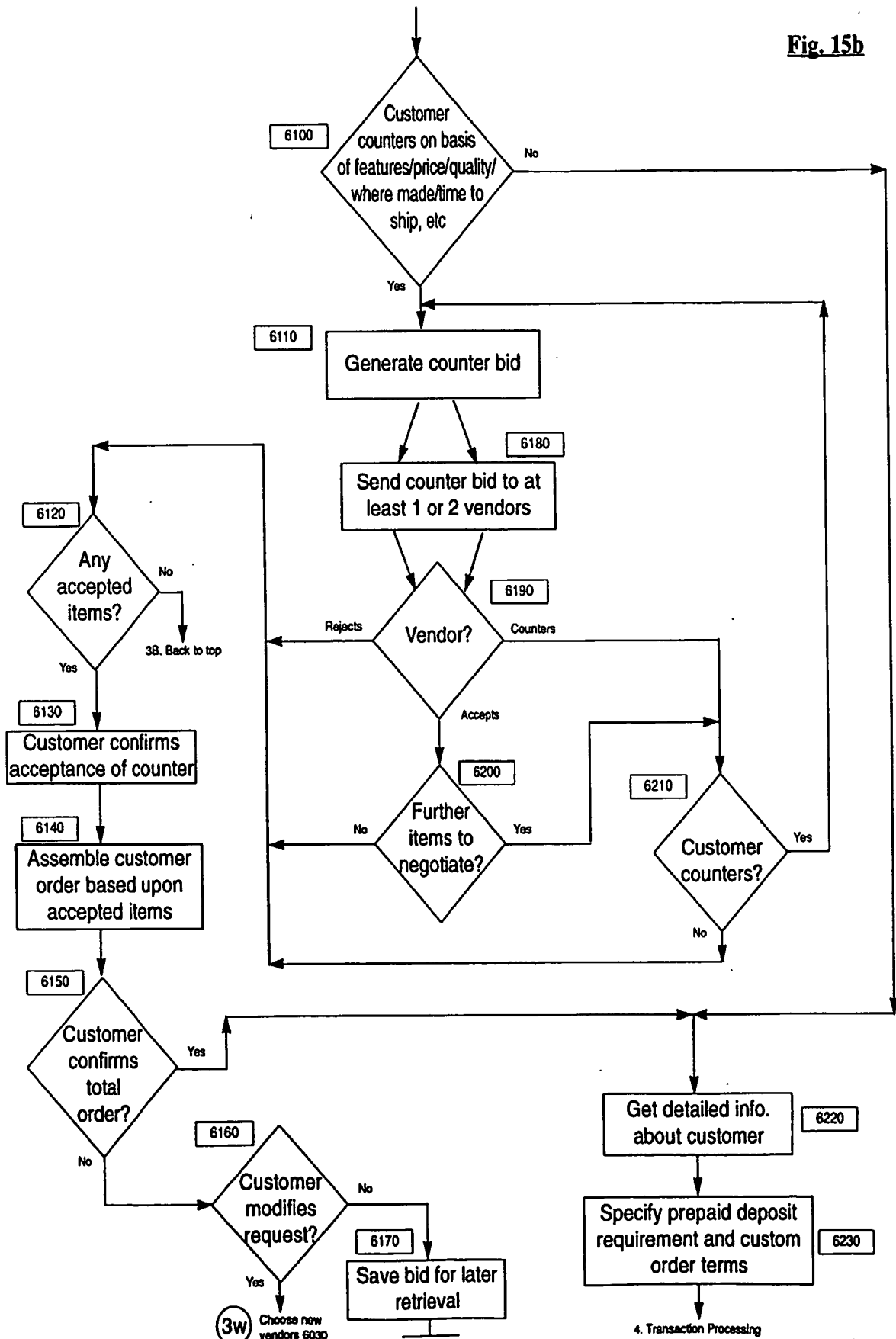
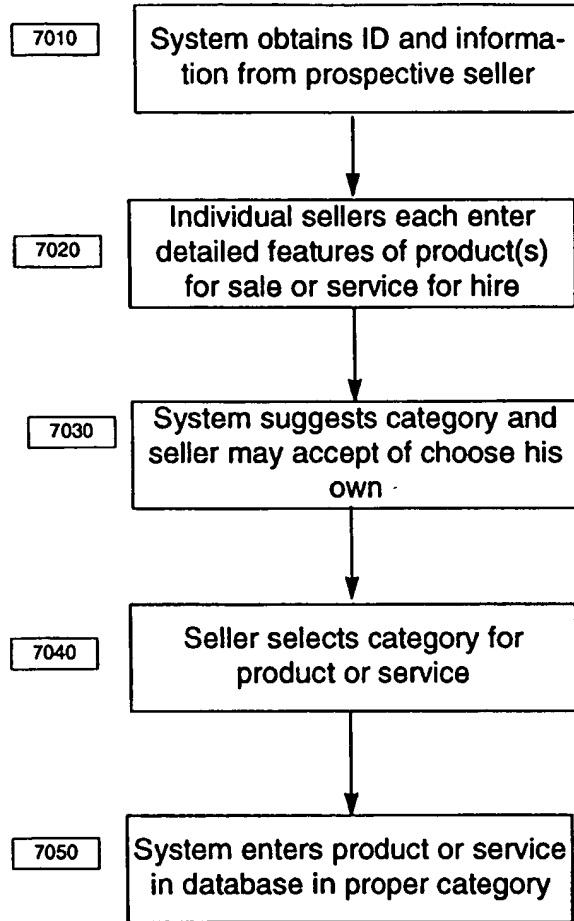

Figure - 16a: 3D. Peer-To-Peer Exchange (a) (7000)
Sell r ent r product or s rvic data into system

Fig. 16a



3D. Peer-To-Peer Exchange (b) (7100) Purchase processes for product or service through an exchange

Fig. 16b

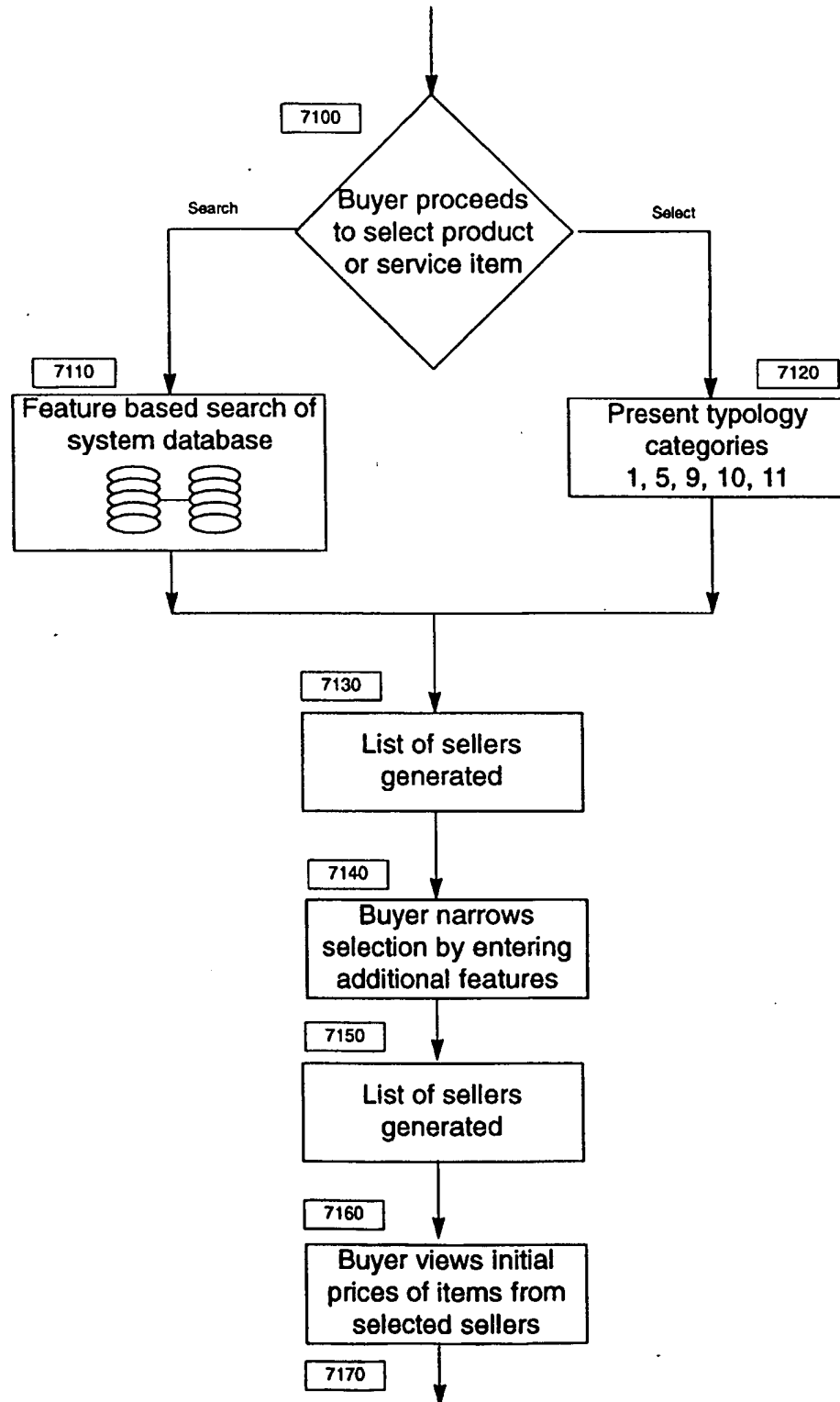
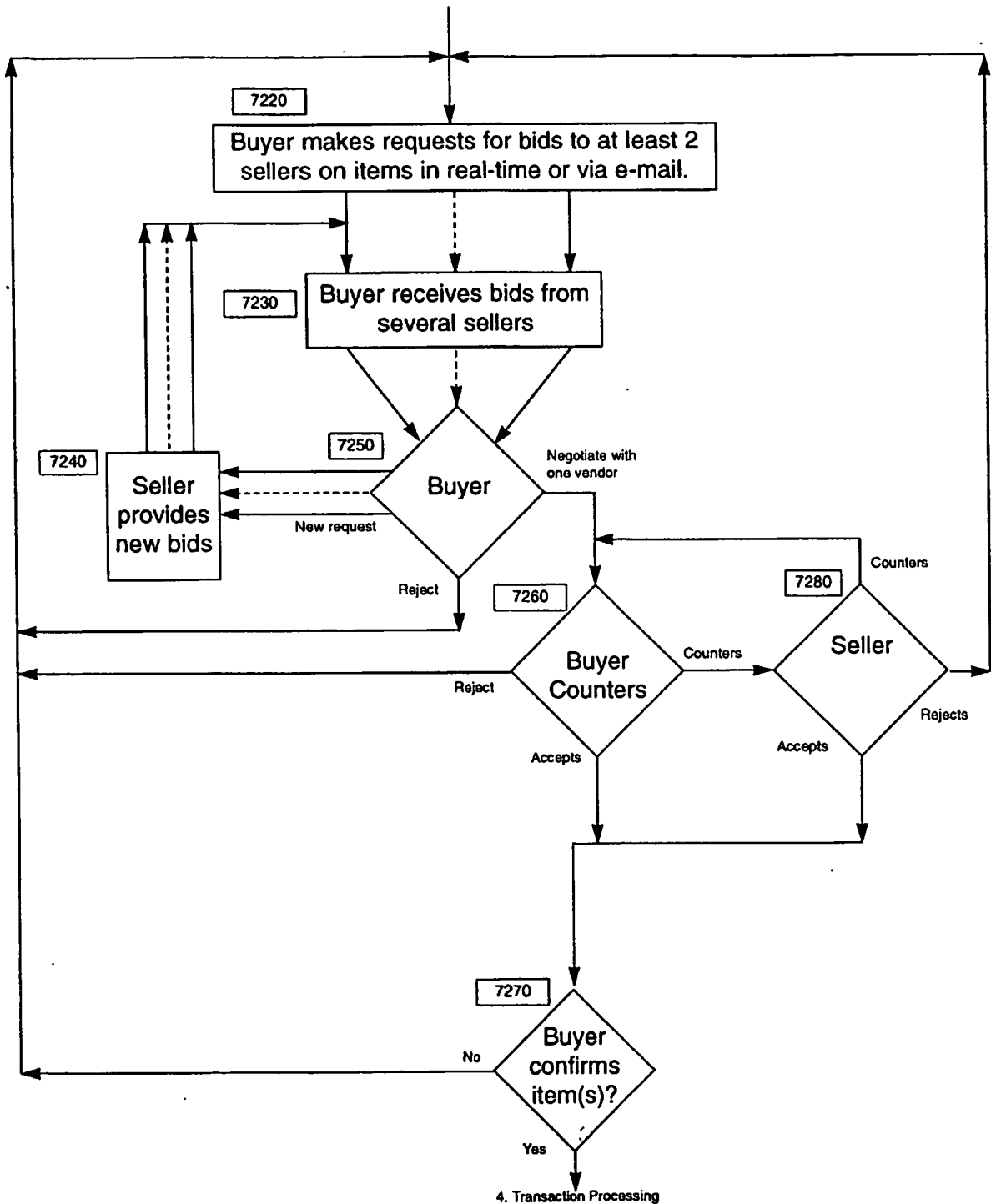
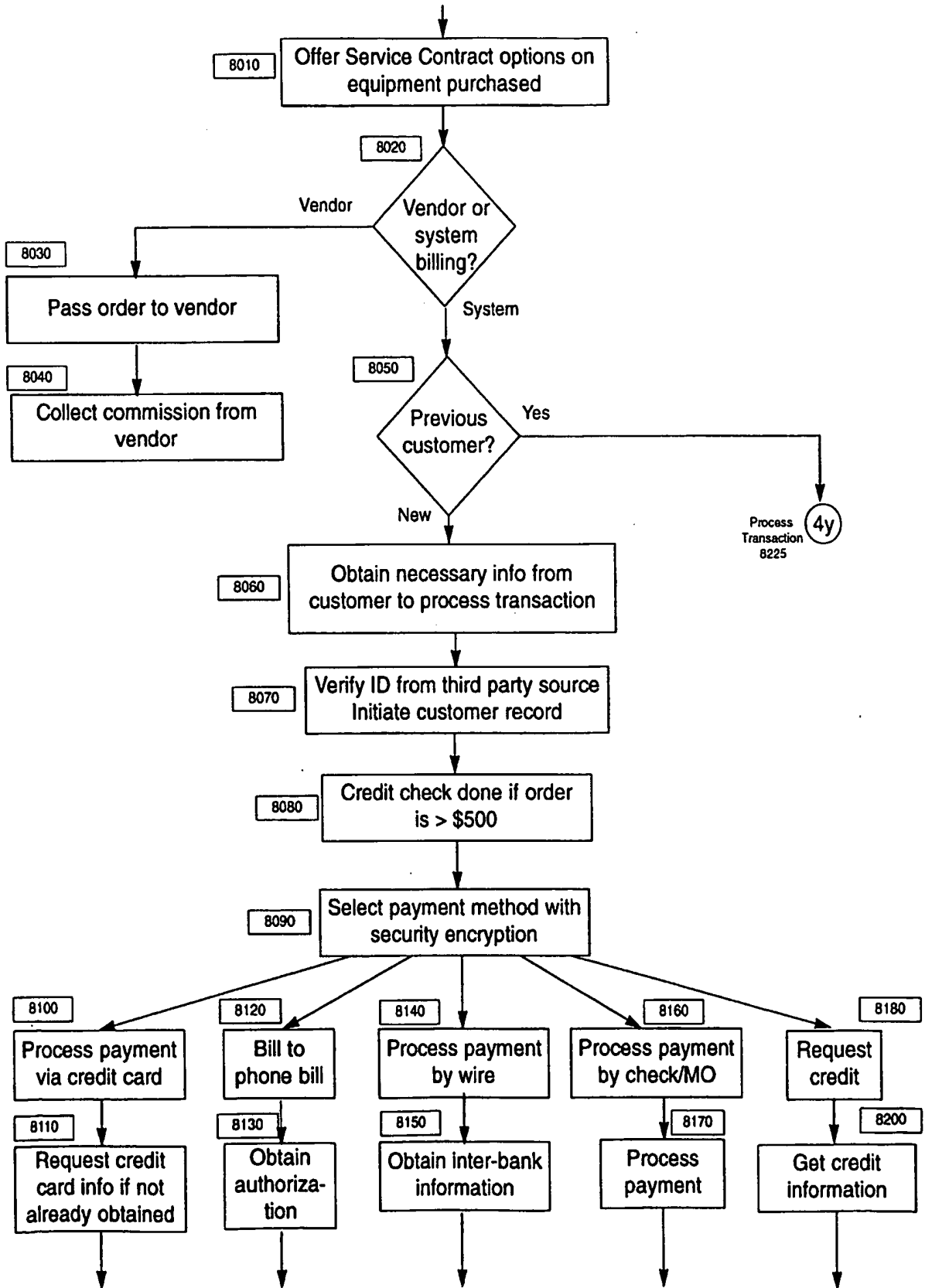

Fig. 16c



From 7100 to 7290 indicates multiple, parallel paths for each customer package

Figure - 17a: 4. Transaction & Post Sale Processing Module (8000)



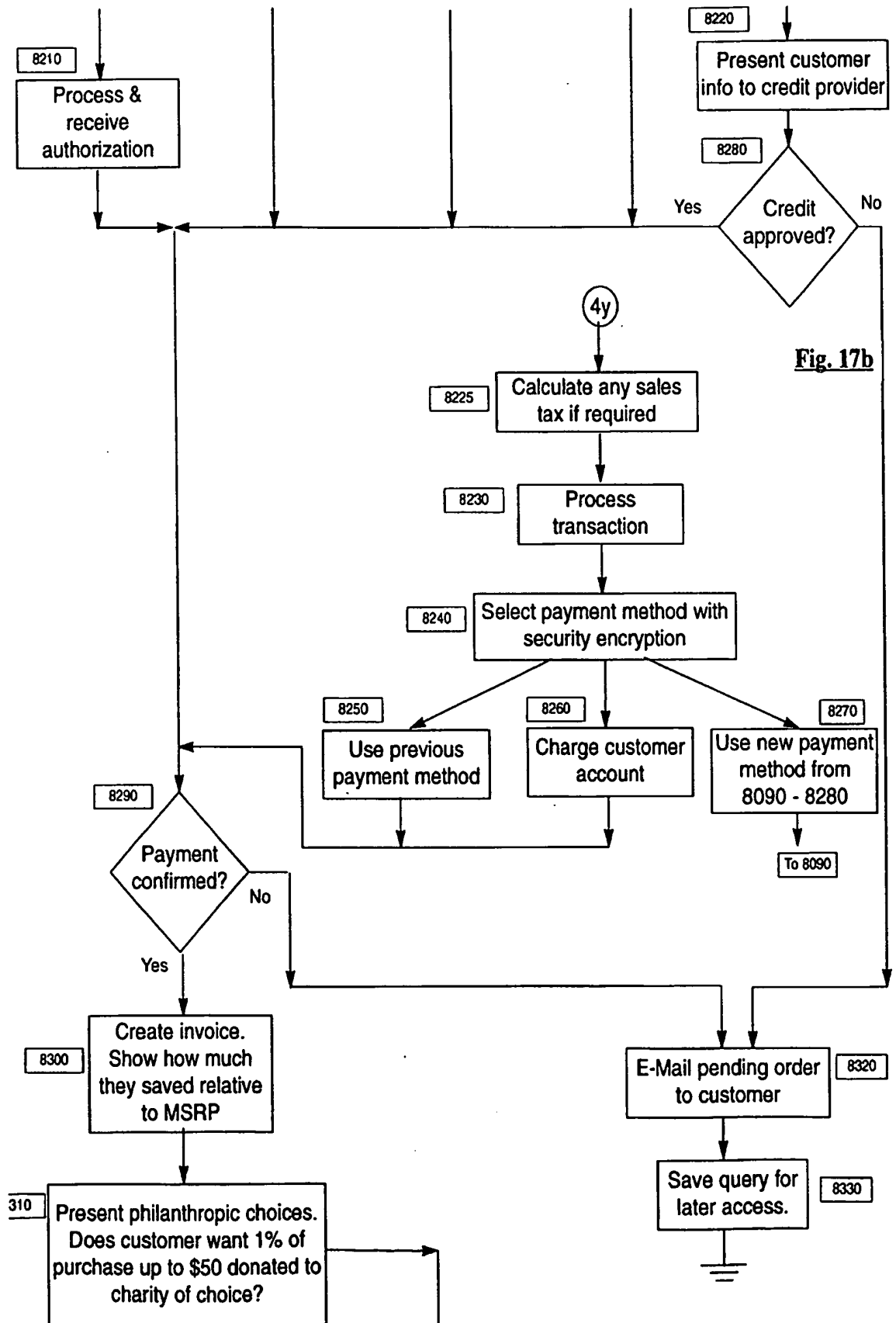
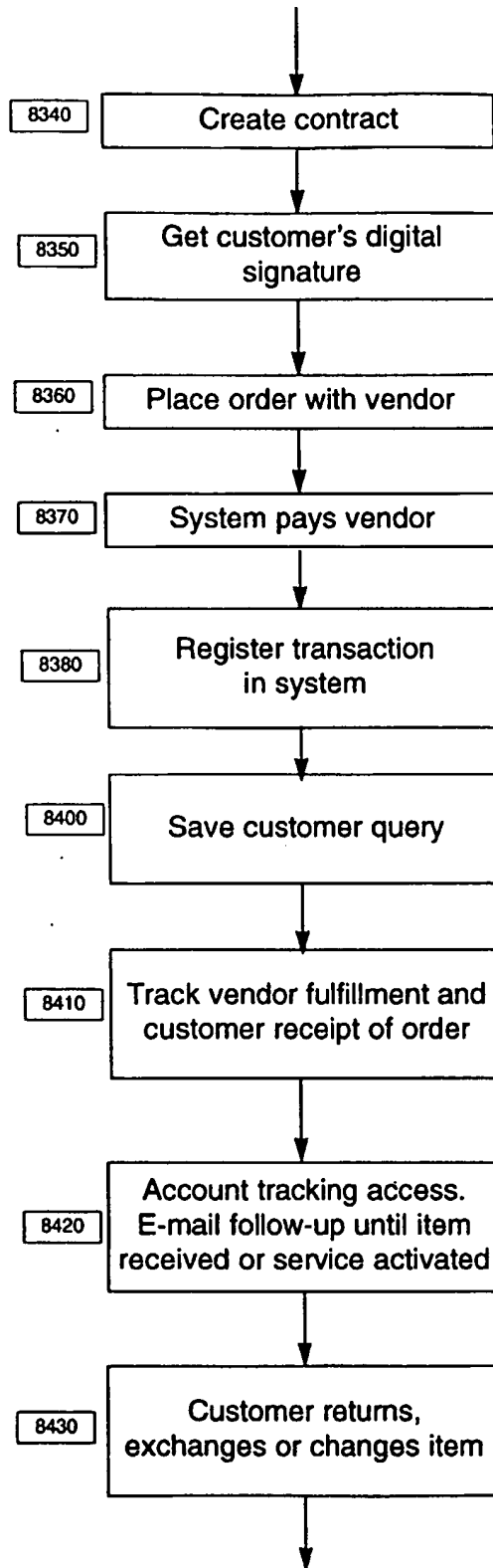

Fig. 17b

Fig. 17c



8500 – Post Sal Processing

Fig. 17d

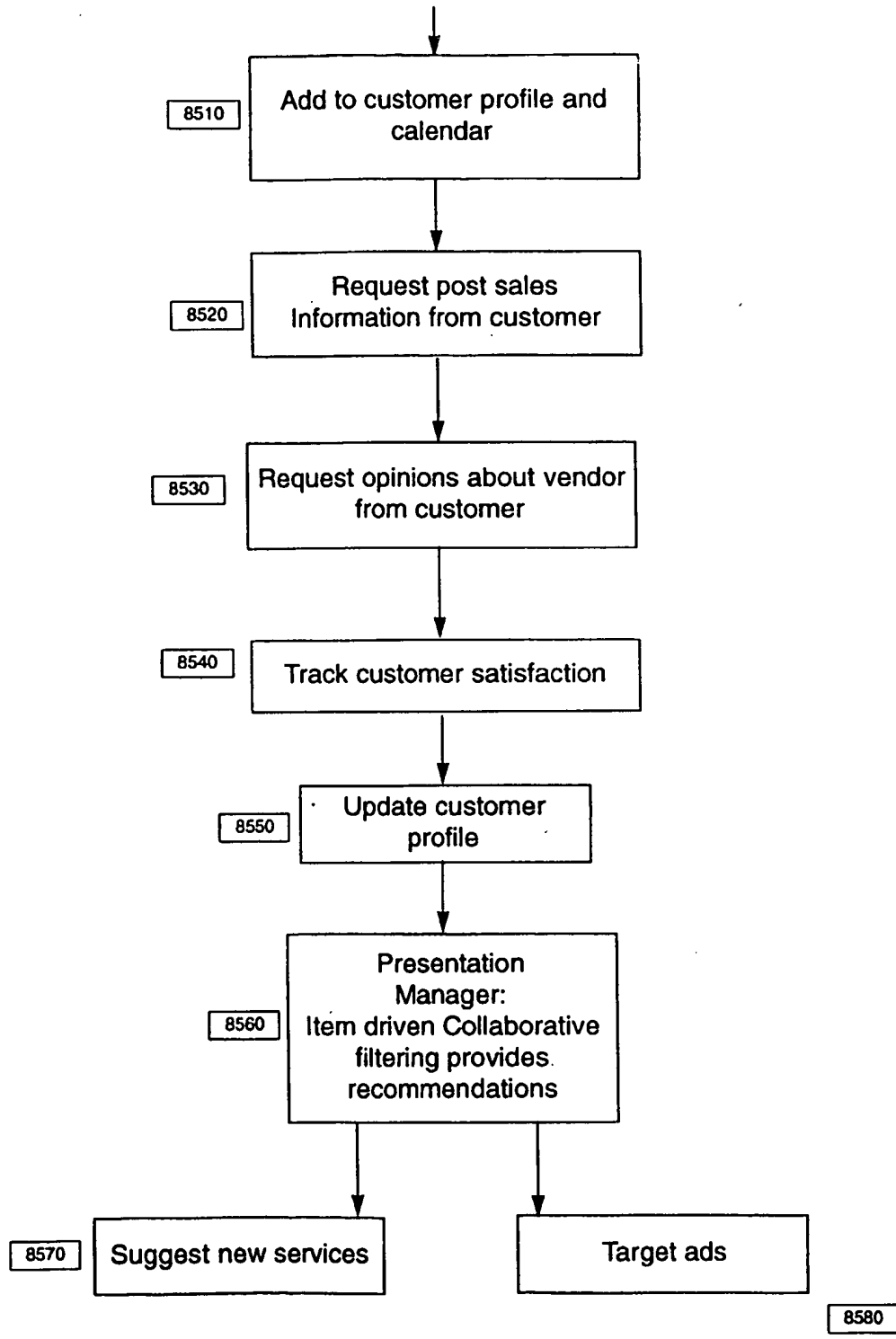
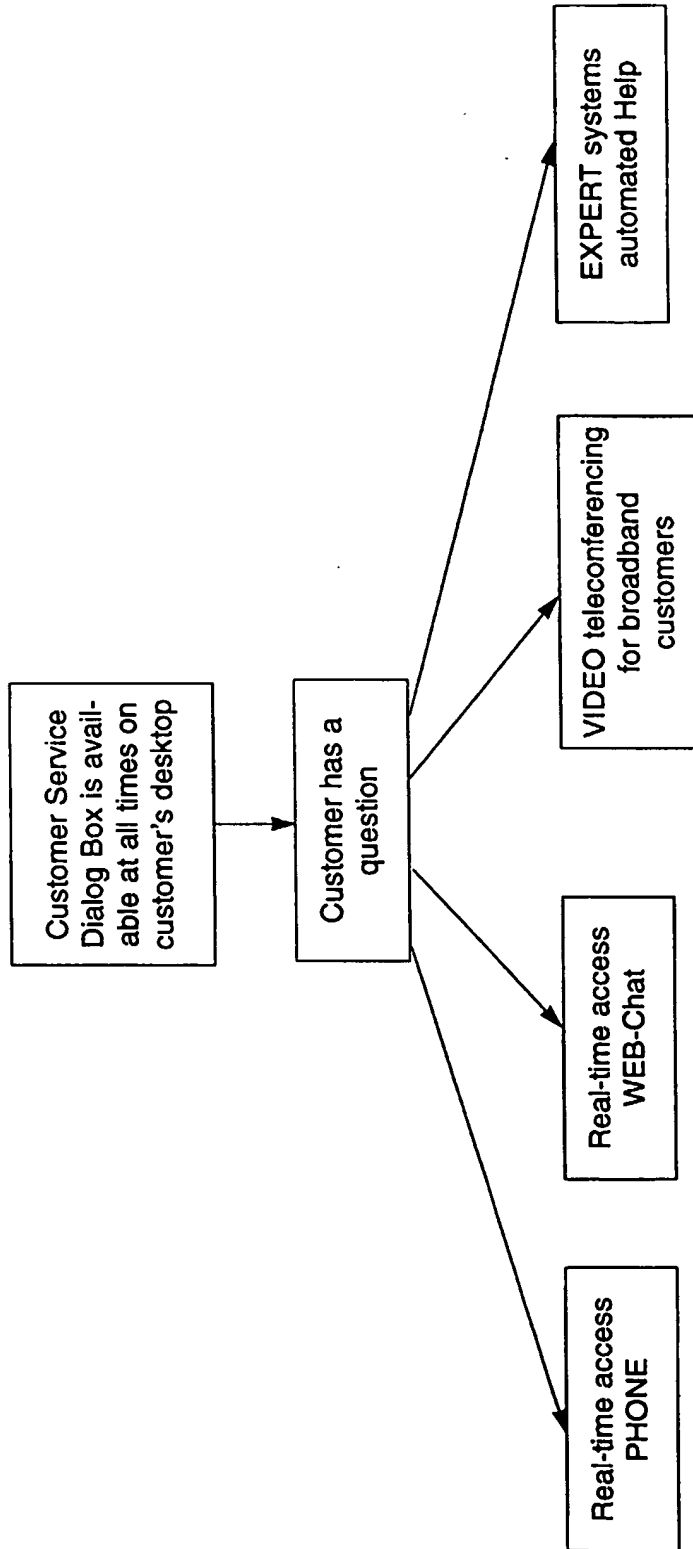

Fig. 18

Customer Service – 1050



Information Center

Fig. 19a

Request Information

Get informed! The AES community compiles ratings and reviews of the best - and worst - service and equipment vendors.

 ▾

Comparison Shopping

Select a product category and AES will instantly compile a comparison chart.

 ▾

Expert Recommendation

Let AES recommend the right telecom equipment, services or applications for you.

Show me my options
based on

 ▾

Create Profile
for best results

Advanced Search

Search the entire AES Web site and database for specific topics.

Enter Keyword(s) **GO**

Expert Recommendations
(Typology of Categories for Collaborative Filtering)

Fig. 19b

PRODUCT OR SERVICE

ITEM

Price)
 Quality) upgrade or
 Features) downgrade

Delivery time

Region of Manufacture

Reputation of Product or Service;

Reliability

TERMS OF TRANSACTION

Payment method

Payment timing

SELLER

Vendor Attributes:

Type of business

Size of business

Revenue of business

Location of business

Reputation of Seller

Quality of Customer Service

BUYER

Customer Profile:

INDIVIDUAL

Age

Education (amount and kind)

Occupation

Income Level

Location

Credit

Customer Reputation

BUSINESS

Kind of Business

Revenue

Growth Rate

Location

Credit

Customer Reputation

Wireless Telecom Service Provider Profiles

Fig. 19c

Wireless Telecom Service Providers

AT&T
 Airtouch
 Broadwing Communications
 Cellular One
 Centurytel
 Comdata

MCI Worldcom
 Nextel
 Pacbell
 SBC
 Sprint
 Verizon
 Voicestream

Broadwing Communications

Location Austin, TX
 Established 1976
 Full-time Employees 3,000
 Type of Company Facilities-based LD carrier
 Regions of Focus Bell Atlantic, Bell South, US West, SW Bell
 Services Provided 1+LD Svc, Calling Card, Exchange Access Svc Operator Svcs,
 Enhanced Svcs, Wireless, Local Svc, TFS, Customized Billing, Intl Svcs,
 Internet Svcs, Data Svcs

Comdata

Location Brentwood, TN
 Established 1969
 Full-time Employees 1,800
 Type of Company Facilities-based LD carrier
 Regions of Focus Bell Atlantic, Bell South, US West, SW Bell
 Services Provided 1+LD Svc, Calling Card, Enhanced Svcs, Wireless, TFS, Fax
 Svcs, Customized Billing, Intl Svcs

MCI WorldCom

Location Clinton, MS
 Established 1983
 Full-time Employees 83,000
 Type of Company Facilities-based LD Carrier, Facilities-based CLEC, Facilities-based
 All-Distance Carrier
 Regions of Focus Bell Atlantic, Bell South, US West, SW Bell
 Services Provided 1+LD Svc, Calling Card, Exchange Access Svc Operator Svcs,
 Enhanced Svcs, Wireless, Local Svcs, TFS, Fax Svcs, Customized Billing, Intl
 Svcs, Internet Svcs, Data Svcs

Rate Charts

Fig. 19d

Pacific Bell

Wireless Rate Chart

Duration Of Contract →				
Min. Monthly Usage (minutes)	6 mos	1 year	2 year	3 Year
50	10¢	9¢	8¢	7¢
100	9¢	8¢	7¢	6.5¢
250	8¢	7.5¢	7¢	6.5
500	7.5¢	7¢	6.5¢	6¢
1,000	7¢	6.5¢	6¢	5.5¢
2,000	6.5¢	6¢	5.5¢	5
5,000	6¢	5.5¢	5¢	4.5¢
10,000	5.5¢	5¢	4.5¢	4¢
25,000	5¢	4.5¢	4¢	3.5¢
50,000	4.5¢	4¢	3.5¢	3¢
100,000 or more	4¢	3.5¢	3¢	2.5¢

• Usage rates do not include fees and taxes

- * Rate Plans are exclusive of special promotions.
- * Rates specify high peak usage or averages of high peak and off-peak usage.
- * You may qualify for free off-peak usgae if you buy more products and services.

Wireless Vendor Ratings

Fig. 19e

Rating	Company	Information	Editorials
★★★★	<u>Pac Bell</u> 1-800-PAC-BELL	Offers 3 levels of service; residential, business & lifeline	<u>review</u>
	<u>Cellular One</u>		
★★★	1-800-TEL-EPHONE		<u>review</u>
★★	<u>Intrastate</u> 1-800-999-9990		<u>review</u>
★★	<u>Extrastate</u> 1-800-999-9990		<u>review</u>
★	<u>Discount Mobiles</u> 1-800-999-9990		<u>review</u>
★	<u>Phone-tastic</u> 1-800-999-0009		<u>review</u>

Vendor, Service & Product Reviews Fig. 19f

Prosumer Reports Telecom Reports

Business Reports Equipment Reports

Telecom Reports

- Teleglobe Launches Telecommunications Vertical Initiative, Telecom Today, August 1999.
- Mobilize Introduces Mobile Application For Presentations, Mobile Times, September 1999.
- Data Services From Wireless: Sooner than you think, Wireless News, October 1999.

Pacific Bell Review

Fig. 19g

Company	Information
<u>Pac Bell</u> 1-800-PAC-BELL	Offers 3 levels of service: residential, business, and lifeline. Etc., etc.

Average review: ★★★★★

Vendor Reviews

"I think Pac Bell is the greatest. I give them four stars, because this rating system doesn't go to five. ★★★★★"

"We'd been using Mountain Bell for years. When we came to California, we were a bit hesitant to try Mountain Bell, even though they sound the same, sort of. But you know what? We didn't have a choice! Even though I'd love to have more choices, I still have to give Pac Bell a high rating. For us, they kind of define quality. ★★★★★"

" I like Pac Bell but I've never used anyone else. For all I know they could be only a three-star operation. ★★★ "

Procurement System Introduction

Fig. 20a

Search by category below:

Make a request based on item features. For example, "two line telephone:

SEARCH SITE

Services	Applications	Equipment
Local Phone	Integrated Telephony	Telephones & Phone Systems
Long Distance	<u>Teleconferencing</u>	<u>PDA's & Mobile Computers</u>
<u>Wireless</u>	Data Services	Routers & Networks
High Speed Internet	Wireless Data	Accessories & Software

Wireless Service Comparison Chart

Fig. 20b

Vendor	Wireless Service Features	Price	check for bid
<u>Pac Bell</u> 1-800-888-BELL ★★☆☆	options: 1. Includes free phone - a \$99 value 2. 500 free minutes per month	\$39.99/mo with 2 year commitment	<input type="checkbox"/>
<u>Cellular One</u> 1-800-TEL-EPHONE ★★☆☆	options: 1. Includes free phone - a \$129 value 2. 1000 free minutes per month	\$49.99/MO with 6 month commitment	<input type="checkbox"/>
<u>Intrastate</u> 1-800-999-9990 ★★☆☆	options: 1. Includes free phone - a \$199 value 2. 500 free minutes per month	\$44.99/MO with 1 year commitment	<input type="checkbox"/>
<u>Extrastate</u> 1-800-999-9990 ★★☆☆	options: 1. Includes free phone - a \$139 value 2. 300 free minutes per month	\$29.99/MO with 3 year commitment	<input type="checkbox"/>
<u>Discount Mobiles</u> 1-800-999-9990 ★☆☆	options: 1. 300 free minutes per month 2.	\$39.99/MO with 1 year commitment and no free telephone	<input type="checkbox"/>
<u>Phone-tastic</u> 1-800-999-0009 ★☆☆	options: 1. Includes free phone - a \$249 value 2. 500 free minutes per month	\$39.99/MO with 3 year commitment and free data services telephone	<input type="checkbox"/>

Wireless Service Vendor Selection Process

Fig. 20c

You have selected the following four services.

1. Please compare these vendors carefully and narrow your choices down to two.
2. Then click on the next button.

If you would like to save this page and come back to it later, click the "Save Chart" button.

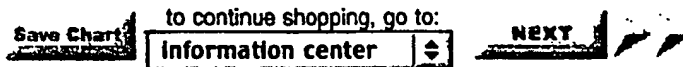

Vendor	Features	Price	check for bid
<u>Pac Bell</u> 1-800-888-BELL ☆☆☆	options: 1. Includes free phone - a \$99 value 2. 500 free minutes per month	\$39.99/mo with 2 year comittment	<input type="checkbox"/>
<u>Cellular One</u> 1-800-TEL-EPHONE ☆☆☆	options: 1. Includes free phone - a \$129 value 2. 1000 free minutes per month	\$49.99/mo with 6 month comittment	<input type="checkbox"/>
<u>Intrastate</u> 1-800-999-9990 ☆☆	options: 1. Includes free phone - a \$199 value 2. 500 free minutes per month	\$44.99/mo with 1 year comittment	<input type="checkbox"/>
<u>Extrastate</u> 1-800-999-9990 ☆☆	options: 1. Includes free phone - a \$139 value 2. 300 free minutes per month	\$29.99/mo with 3 year comittment	<input type="checkbox"/>

Negotiation Process Wireless Service Narrowing of Selection

Fig. 20d

Congratulations!
You have narrowed your choices down to two services.

From this page, you can either:

- 1) **accept one of the plans by checking the "accept" box and hitting the "submit" button, OR**
- 2) **submit counter offer by entering a dollar bid or features in the "counter" box, and hitting the "submit " button.**

Vendor	Features	Price	Accept	New bid
Pac Bell 1-800-888-BELL ☆☆☆☆	<input type="radio"/> optional feature 1 <input type="radio"/> optional feature 2	\$39.99/mo with 2 year commitment	<input type="checkbox"/>	<input type="text"/>
Cellular One 1-800-TEL-EPHONE ☆☆☆	<input type="radio"/> optional feature 1 <input type="radio"/> optional feature 2	\$49.99/mo with 6 month commitment	<input type="checkbox"/>	<input type="text"/>

Save Chart

GO BACK

SUBMIT

Negotiation Process Wireless Service Request for New Bids

Fig. 20e

From this page, you can either:

- 1) accept one of the plans by checking the "accept" box and hitting the "submit" button, OR
- 2) request New Bids by entering a dollar bid or features in the New Bids column, and hitting the "submit" button.

Vendor	Features	Price	Accept	New Bids
<u>Pac Bell</u> 1-800-888-BELL ☆☆☆☆	<input type="radio"/> optional feature 1 <input type="radio"/> optional feature 2	\$39.99/mo with 2 year commitment	<input checked="" type="checkbox"/>	\$34.99 with better phone
<u>Cellular One</u> 1-800-TEL-EPHONE ☆☆☆	<input type="radio"/> optional feature 1 <input type="radio"/> optional feature 2	\$49.99/mo with 6 month commitment	<input type="checkbox"/>	\$44.95 for 1 yr. & better phor

Save Chart

GO BACK

SUBMIT

Negotiation Process Wireless Service New Bid by Vendor

Fig. 20f

The Vendors have submitted new bids with the following:

- 1) accept one of the plans by checking the "accept" box and hitting the "submit" button, OR
- 2) press "go back" to request other bids, OR
- 3) enter a dollar amount or features in the "counter" box and press "submit" to give a counter-offer to a single preferred vendor.

Vendor	Features	Price	Accept	New Bids
<u>Pac Bell</u> 1-800-888-BELL ★★☆☆	<input checked="" type="radio"/> optional feature 1 <input checked="" type="radio"/> optional feature 2	\$39.99/mo with 2 year commitment	<input type="checkbox"/>	<div style="border: 1px solid black; padding: 2px;">\$36.95 with no better phone</div>
<u>Cellular One</u> 1-800-TEL-EPHONE ★☆☆	<input type="radio"/> optional feature 1 <input checked="" type="radio"/> optional feature 2	\$49.99/mo with 6 month commitment	<input type="checkbox"/>	<div style="border: 1px solid black; padding: 2px;">\$49.95 for 1 yr. & better phone</div>

Save Chart

GO BACK

SUBMIT

Negotiation Process Wireless Service

Customer Counter Offer to Preferred Vendor

Fig. 20g

From this page, you can either:

- 1) accept the Vendor's offer by selecting the "Accept" button and hitting the "submit" button, OR
- 2) enter a dollar amount or features in the "counter" box and press "submit" to give a counter-offer.

Vendor	Features	Price	Accept	Make Counter Offer
Pac Bell 1-800-888-BELL ★★☆☆	<input type="checkbox"/> optional feature 1 <input type="checkbox"/> optional feature 2	\$39.99/mo with 2 year commitment	<input type="checkbox"/>	\$36.95 with better phone
<input type="button" value="Save Chart"/>		<input type="button" value="GO BACK"/>		<input type="button" value="SUBMIT"/>

Negotiation Process Wireless Service Vendor's Best Offer

Fig. 20h

This bid is the vendor's best offer.

Please press **SUBMIT** to confirm your acceptance and to process the transaction.

Vendor	Features	Price	Accept	Accepted Price with features
<u>Pac Bell</u> 1-800-888-BELL ☆☆☆☆	optional feature 1 optional feature 2	\$39.99/mo with 2 year commitment	<input type="checkbox"/>	\$36.95 with better phone

Save Chart

GO BACK

SUBMIT

Negotiation Process Wireless Service Customer Offer Acceptance

Fig. 20i

Congratulations!
You have completed the bidding process.

From this page, you can either:

Proceed to Transaction Processing by clicking the **Checkout** button or you may go back.

Vendor	GO BACK	Features	Checkout	Status
<u>Pac Bell</u> 1-800-888-BELL ★★☆☆		optional feature 1 optional feature 2	\$39.99/mo with 2 year commitment	\$36.95 with better phone

Transaction Processing

Fig. 21

Congratulations on successfully bidding for your service!

Quantity	Item	Price
1	PacBell Wireless Service	\$36.95/mo with better phone

note: the best savings are found on bundling items. [Click here](#) for more details.

Name:

Business Name:

Position/role:

Address :

Phone

Other Info:

Verify

Payment method:

bill me monthly

auto withdrawal

credit card



Tell me more about

Philanthropy:

If you would like 1% of your bill (up to a maximum of \$50) to go to charity, then:



Please press here to complete your transaction

INTERNATIONAL SEARCH REPORT

International application No.

PCT/US00/30249

A. CLASSIFICATION OF SUBJECT MATTER		
IPC(7) :G06F 17/60 US CL :705/37, 26 According to International Patent Classification (IPC) or to both national classification and IPC		
B. FIELDS SEARCHED		
Minimum documentation searched (classification system followed by classification symbols) U.S. : 705/37, 26		
Documentation searched other than minimum documentation to the extent that such documents are included in the fields searched NONE		
Electronic data base consulted during the international search (name of data base and, where practicable, search terms used) WEST 2.0		
C. DOCUMENTS CONSIDERED TO BE RELEVANT		
Category*	Citation of document, with indication, where appropriate, of the relevant passages	Relevant to claim No.
X — Y	US 5,950,178 A (BORGATO) 07 SEPTEMBER 1999, entire document	1, 4-20, 117, 118, 125, 126, 134, 174, 231, 232, 241,257 ----- 247, 248, 251, 305
X — Y	US 5,835,896 A (FISHER et al) 10 November 1998, entire document	175,176 ----- 247, 248, 251, 305
A	US 5,905,975 A (AUSUBEL) 18 May 1999 , entire document	1-364
<input checked="" type="checkbox"/> Further documents are listed in the continuation of Box C. <input type="checkbox"/> See patent family annex.		
* Special categories of cited documents:	"T"	later document published after the international filing date or priority date and not in conflict with the application but cited to understand the principle or theory underlying the invention
"A" document defining the general state of the art which is not considered to be of particular relevance	"X"	document of particular relevance; the claimed invention cannot be considered novel or cannot be considered to involve an inventive step when the document is taken alone
"E" earlier document published on or after the international filing date	"Y"	document of particular relevance; the claimed invention cannot be considered to involve an inventive step when the document is combined with one or more other such documents, such combination being obvious to a person skilled in the art
"L" document which may throw doubts on priority claim(s) or which is cited to establish the publication date of another citation or other special reason (as specified)	"&"	document member of the same patent family
"O" document referring to an oral disclosure, use, exhibition or other means		
"P" document published prior to the international filing date but later than the priority date claimed		
Date of the actual completion of the international search 15 FEBRUARY 2001	Date of mailing of the international search report 11 APR 2001	
Name and mailing address of the ISA/US Commissioner of Patents and Trademarks Box PCT Washington, D.C. 20231 Facsimile No. (703) 305-3230	Authorized officer VINCENT MILLIN <i>James R. Matthews</i> Telephone No. (703) 308-1065	

INTERNATIONAL SEARCH REPORT

International application No.
PCT/US00/30249

C (Continuation). DOCUMENTS CONSIDERED TO BE RELEVANT		
Category*	Citation of document, with indication, where appropriate, of the relevant passages	Relevant to claim No.
A	US 5,890,138 A (GODIN et al) 30 March 1999, entire document	1-364